

snom

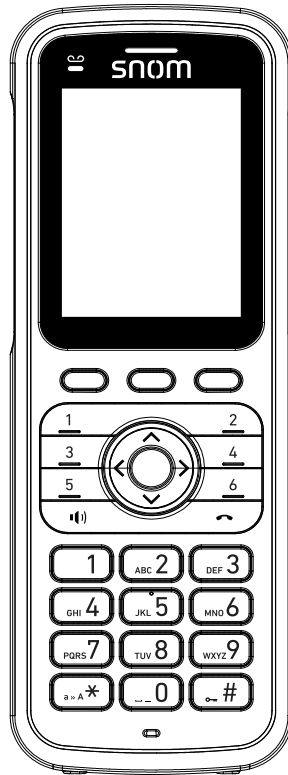

## M56

SIP DECT Rugged Handset  
User Manual

# User Manual

## M56

### SIP DECT Handset

#### Table of Contents

<b>Copyright, Trademarks, Legal Disclaimers</b> .....	<b>4</b>
---	----------

<b>Important Safety Information</b> .....	<b>5</b>
---	----------

Important safety instructions .....	5
-------------------------------------	---

<b>For cUL compliance only</b> .....	<b>8</b>
--------------------------------------	----------

<b>Mesures de sécurité importantes</b> .....	<b>8</b>
--	----------

Mesures de sécurité importantes .....	8
---------------------------------------	---

<b>Compliance</b> .....	<b>11</b>
-------------------------	-----------

FCC part 15 .....	11
-------------------	----

FCC Part 68 .....	11
-------------------	----

Industry Canada .....	12
-----------------------	----

<b>Introduction</b> .....	<b>13</b>
---------------------------	-----------

About this manual .....	13
-------------------------	----

Product overview .....	14
------------------------	----

<b>Quick Reference Guide</b> .....	<b>15</b>
------------------------------------	-----------

Cordless handset external features .....	15
--	----

<b>Quick Reference Guide</b> .....	<b>16</b>
------------------------------------	-----------

Cordless handset external features .....	16
--	----

<b>Factory Default Programmable Feature Key (PFK) Settings</b> .....	<b>17</b>
--	-----------

<b>Handset Installation</b> .....	<b>18</b>
-----------------------------------	-----------

Installing the charger .....	19
------------------------------	----

Battery installation and charging .....	20
---	----

Wall mounting the charger .....	23
---------------------------------	----

Adding a corded headset .....	24
-------------------------------	----

Turning the headset on/off .....	24
----------------------------------	----

<b>Handset Registration</b> .....	<b>25</b>
-----------------------------------	-----------

Auto-registering the handset to the base station .....	25
--	----

Registering by entering the handset's IPEI on the Web UI .....	26
--	----

Manually registering via the LINK key on base station .....	27
---	----

Manually registering via the Web UI .....	28
---	----

Deregistering the handset .....	29
---------------------------------	----

<b>Screen icons</b> .....	<b>30</b>
---------------------------	-----------

<b>Using the Handset</b> .....	<b>33</b>
--------------------------------	-----------

Idle screen .....	33
-------------------	----

Password warning on the Idle screen .....	33
---	----

Main Menu .....	34
-----------------	----

Making calls .....	35
--------------------	----

Answering calls .....	37
-----------------------	----

Answering multiple incoming calls .....	38
---	----

Ending a call .....	38
---------------------	----

Volume .....	38
--------------	----

Mute .....	38
------------	----

Speakerphone .....	38
--------------------	----

Corded Headset .....	38
----------------------	----

Bluetooth headset .....	39
-------------------------	----

Call Waiting .....	39
--------------------	----

Missed Calls .....	39
--------------------	----

Putting a call on hold .....	40
------------------------------	----

Putting a call on private hold .....	41
--------------------------------------	----

Switching between two calls .....	42
-----------------------------------	----

Paging a group of handsets/desksets .....	43
---	----

Receiving a page .....	43
------------------------	----

About Shared Calls .....	44
--------------------------	----

Displaying calls on the Call List .....	47
---	----

Barging In .....	48
------------------	----

Call Privacy .....	48
--------------------	----

Using Shared Call Emulation .....	49	Setting lift handset to answer.....	73
Transferring a call .....	52	Setting the missed call alert.....	73
Setting up a conference call .....	53	Registering or deregistering your deskset .....	73
Putting a conference call on hold .....	54	<b>WebUI</b> .....	<b>74</b>
Listening to messages .....	55	Using the WebUI.....	74
Using the Directory .....	56	How to identify the IP address of the base station.....	74
Using the Call History.....	59	Accessing the WebUI.....	76
Locking the keypad .....	60	System Status .....	77
Using the flashlight .....	61	Cordless Registrations.....	78
Emergency alarm .....	62	Cordless Status.....	78
<b>Connecting a Bluetooth Headset</b> .....	<b>63</b>	Base Status .....	79
Opening the Bluetooth menu.....	63	Base Preferences.....	79
Adding a Bluetooth headset to the Device list.....	63	User Preferences .....	79
Using the Device list.....	64	Base Directory .....	80
<b>Configuring the Handset</b> .....	<b>66</b>	Blocked List .....	83
Setting call waiting .....	66	Remote XML.....	83
Viewing handset status .....	66	Security .....	84
Setting the language .....	67	<b>Troubleshooting</b> .....	<b>85</b>
Setting the display options .....	68	General issues .....	85
Setting the keypad light .....	68	<b>Technical Specifications</b> .....	<b>86</b>
Setting Silent Mode.....	69	<b>Special characters</b> .....	<b>87</b>
Setting the ringer tone and volume .....	69	Entering special characters.....	87
Setting the vibration.....	70	<b>Maintenance</b> .....	<b>88</b>
Setting the advisory tones.....	71	Taking care of your telephone .....	88
Setting Auto ans audio .....	71		
Setting Speed Dial entries.....	72		

# Copyright, Trademarks, Legal Disclaimers

Copyright © 2024 Snom Technology GmbH

All Rights Reserved.

Snom, the names of Snom products, and Snom logos are trademarks owned by Snom Technology GmbH. All other product names and names of enterprises are the property of their respective owners.

Product specifications are subject to change without notice.

Snom Technology GmbH reserves the right to revise and change this document at any time, without being obliged to announce such revisions or changes beforehand or after the fact.

Texts, images, and illustrations and their arrangement in this document are subject to the protection of copyrights and other legal rights worldwide. Their use, reproduction, and transmittal to third parties without express written permission may result in legal proceedings in the criminal courts as well as civil courts.

When this document is made available on Snom's web page, Snom Technology GmbH gives its permission to download and print copies of its content for the intended purpose of using it as a manual. No parts of this document may be altered, modified or used for commercial purposes without the express written consent of Snom Technology GmbH.

Although due care has been taken in the compilation and presentation of the information in this document, the data upon which it is based may have changed in the meantime. Snom therefore disclaims all warranties and liability for the accurateness, completeness, and currentness of the information published, except in the case of intention or gross negligence on the part of Snom or where liability arises due to binding legal provisions.

# Important Safety Information



This symbol is to alert you to important operating or servicing instructions that may appear on the product or in this user's manual. Always follow basic safety precautions when using this product to reduce the risk of injury, fire, or electric shock.

## Important safety instructions

---

When using your telephone equipment, basic safety precautions should always be followed to reduce the risk of fire, electric shock and injury, including the following:

1. This product should be installed by a qualified technician.
2. This product should only be connected to the host equipment and never directly to the network such as Public Switch Telephone Network (PSTN) or Plain Old Telephone Services (POTS).
3. Read and understand all instructions.
4. Follow all warnings and instructions marked on the product.
5. Unplug this product from the wall outlet before cleaning. Do not use liquid or aerosol cleaners. Use a damp cloth for cleaning.
6. Do not use this product near water such as near a bath tub, wash bowl, kitchen sink, laundry tub or swimming pool, or in a wet basement or shower.
7. Do not place this product on an unstable table, shelf, stand or other unstable surfaces.
8. Slots and openings in the back or bottom of the handset are provided for ventilation. To protect them from overheating, these openings must not be blocked by placing the product on a soft surface such as a bed, sofa or rug. This product should never be placed near or over a radiator or heat register. This product should not be placed in any area where proper ventilation is not provided.
9. This product should be operated only from the type of power source indicated on the marking label. If you are not sure of the type of power supplied at the premises, consult your dealer or local power company.
10. Do not allow anything to rest on the power cord. Do not install this product where the cord may be walked on.
11. Never push objects of any kind into this product through the slots in the handset because they may touch dangerous voltage points or create a short circuit. Never spill liquid of any kind on the product.
12. To reduce the risk of electric shock, do not disassemble this product, but take it to an authorized service facility. Opening or removing parts of the base station or handset other than specified access doors may expose you to dangerous voltages or other risks. Incorrect reassembling can cause electric shock when the product is subsequently used.
13. Do not overload wall outlets and extension cords.

14. Unplug this product from the wall outlet and refer servicing to an authorized service facility under the following conditions:
  - A. When the power supply cord or plug is damaged or frayed.
  - B. If liquid has been spilled onto the product.
  - C. If the product has been exposed to rain or water.
  - D. If the product does not operate normally by following the operating instructions. Adjust only those controls that are covered by the operation instructions. Improper adjustment of other controls may result in damage and often requires extensive work by an authorized technician to restore the product to normal operation.
  - E. If the product has been dropped and the telephone base and/or handset has been damaged.
  - F. If the product exhibits a distinct change in performance.
15. Avoid using a telephone (other than cordless) during an electrical storm. There is a remote risk of electric shock from lightning.
16. Do not use the telephone to report a gas leak in the vicinity of the leak. Under certain circumstances, a spark may be created when the adapter is plugged into the power outlet, or when the handset is replaced in its cradle. This is a common event associated with the closing of any electrical circuit. The user should not plug the phone into a power outlet, and should not put a charged handset into the cradle, if the phone is located in an environment containing concentrations of flammable or flame-supporting gases, unless there is adequate ventilation. A spark in such an environment could create a fire or explosion. Such environments might include: medical use of oxygen without adequate ventilation; industrial gases (cleaning solvents; gasoline vapors; etc.); a leak of natural gas; etc.
17. Only put the handset of your telephone next to your ear when it is in normal talk mode.
18. The power adapters are intended to be correctly oriented in a vertical or floor mount position. The prongs are not designed to hold the plug in place if it is plugged into a ceiling, under-the-table or cabinet outlet.
19. Use only the power cord indicated in this manual.
20. For pluggable equipment, the socket-outlet shall be installed near the equipment and shall be easily accessible.
21. In wall mounting position, make sure to mount the telephone base on the wall by aligning the eyelets with the mounting studs of the wall plate. Then slide the telephone base down on both mounting studs until it locks into place. Mount the device only at heights not exceeding 2 meters. Refer to the full installation instructions in "Handset Installation" on page 18-22 in this User Manual.
22. CAUTION: Keep small metallic objects such as pins and staples away from the handset receiver.
23. WARNING: The product included (ITE) in this manual is to be connected only to PoE networks without routing to the outside plant.

**SAVE THESE INSTRUCTIONS**

<p>Power requirements</p> 	<p>Handset charger power adapter: 5.0Vdc 2A (Model number: NBS10B050200VUU)</p> <p>Handset battery: 3.7V 1350mAh, Li-ion Polymer battery (Model number: 573554, Manufacturer: Shenzhen EPT Battery Co., Ltd.)</p>
--	---

## CAUTION

- The battery cannot be subjected to high or low extreme temperatures during use, storage or transportation.
- The battery cannot be subjected to low air pressure at high altitude during use, storage or transportation.
- The battery in the product is replaceable. There is a danger of explosion if the battery is incorrectly replaced.
- Replacement of a battery with an incorrect type can result in an explosion or the leakage of flammable liquid or gas.
- Avoid disposal of a battery into fire or a hot oven, or mechanically crushing or cutting of a battery, that can result in an explosion.
- Avoid leaving a battery in an extremely high temperature surrounding environment that can result in an explosion or the leakage of flammable liquid or gas.
- A battery subjected to extremely low air pressure may result in an explosion or the leakage of flammable liquid or gas.

## For cUL compliance only

### Mesures de sécurité importantes



Ce symbole vous alertera d'informations importantes ou d'instructions d'entretien pouvant apparaître dans ce guide d'utilisation. Respectez toujours les mesures de sécurité et de sécurité de base lorsque vous utilisez ce produit, afin de réduire les risques de blessures, d'incendie, ou d'électrocution.

#### Mesures de sécurité importantes

---

Afin de réduire les risques d'incendie, de blessures corporelles ou d'électrocution, suivez toujours ces mesures préventives de base lorsque vous utilisez votre téléphone

1. Cet appareil doit être installé par un technicien qualifié.
2. Cet appareil doit être branché à un équipement hôte et jamais branché à un réseau, tel qu'un réseau PSTN publique ou un réseau téléphonique standard (POTS).
3. Lisez et comprenez bien toutes les instructions.
4. Observez toutes les instructions et mises en garde inscrites sur l'appareil.
5. Débranchez ce téléphone de la prise murale avant de le nettoyer. N'utilisez pas de nettoyeurs liquides ni en aérosol. N'utilisez qu'un chiffon doux et légèrement humecté.
6. N'utilisez pas ce produit près de l'eau, tel que près d'un bain, d'un lavabo, d'un évier de cuisine, d'un bac de lavage ou d'une piscine, ou dans un sous-sol humide ou sous la douche.
7. Ne déposez pas ce téléphone sur un chariot, support ou table chancelants. L'appareil pourrait tomber et être sérieusement endommagé.
8. Le boîtier de l'appareil est doté de fentes et d'ouvertures d'aération situées à l'arrière ou en dessous. Afin d'empêcher la surchauffe, ces ouvertures ne doivent pas être obstruées en plaçant l'appareil sur un lit, divan, tapis ou autre surface similaires. Ne placez pas cet appareil à proximité d'un élément de chauffage ni d'une plinthe électrique. De plus, ne l'installez pas dans une unité murale ou un cabinet fermé qui ne possède pas d'aération adéquate.
9. Ne faites fonctionner cet appareil qu'avec le type d'alimentation indiqué sur les étiquettes de l'appareil. Si vous ne connaissez pas le voltage de votre maison, consultez votre marchand ou votre fournisseur d'électricité.
10. Ne déposez rien sur le cordon d'alimentation. Installez cet appareil dans un endroit sécuritaire, là où personne ne pourra trébucher sur la ligne d'alimentation ni le cordon téléphonique modulaire.
11. N'insérez jamais d'objets à travers les fentes et ouvertures de cet appareil, car ils pourraient toucher à des points de tension dangereux ou court-circuiter des pièces, ce qui constituerait un risque d'incendie ou d'électrocution. N'échappez pas de liquides dans l'appareil.
12. Afin de réduire les risques d'électrocution, ne démontez pas l'appareil, mais apportez-le plutôt à un centre de service qualifié s'il doit être réparé. En enlevant



le couvercle, vous vous exposez à des tensions dangereuses ou autres dangers similaires. Un remontage inadéquat peut être à l'origine d'une électrocution lors d'une utilisation ultérieure de l'appareil.

13. Ne surchargez pas les prises de courant ni les rallonges électriques, car ceci peut constituer un risque d'incendie ou d'électrocution.
14. Débranchez cet appareil de la prise de courant et communiquez avec le département de service à la clientèle de Snom dans les cas suivants:
  - A. Lorsque le cordon d'alimentation est endommagé ou écorché.
  - B. Si du liquide a été échappé dans l'appareil.
  - C. Si l'appareil a été exposé à une source d'humidité telle que la pluie ou l'eau.
  - D. Si l'appareil ne fonctionne pas normalement en suivant les directives du guide. N'ajustez que les commandes couvertes dans le guide d'utilisation, car un mauvais réglage de celles-ci peut être à l'origine de dommages, ce qui nécessiterait des réparations considérables pour remettre l'appareil à son état de fonctionnement normal.
  - E. Si l'appareil a été échappé ou son boîtier, endommagé.
  - F. Si le produit affiche une nette diminution de sa performance.
15. Évitez d'utiliser un téléphone (autre qu'un sans fil) pendant un orage. Les éclairs peuvent être à l'origine d'une électrocution.
16. N'utilisez pas le téléphone pour rapporter une fuite de gaz à proximité de celle-ci. Sous certaines circonstances, une inteiincelle pourrait survenir lorsque l'adaptateur est branché à une prise de courant, ou lorsque le combiné est déposé sur le combiné. Ceci est un événement commun associé avec la fermeture d'un circuit électrique. L'utilisateur ne devrait pas brancher le téléphone dans une prise de courant, et ne devrait pas déposer le combiné chargé sur le socle, si le téléphone se trouve dans un environnement où la concentration de gaz inflammables, sans ventilation adéquate. Une étincelle dans ces endroits pourrait provoquer un incendie ou une explosion. Ces environnements pourraient être l'utilisation médicale de l'oxygène sans ventilation adéquate; le gaz industriel (dissolvants, vapeurs d'essence, etc.); une fuite de gaz naturel, etc.
17. Placez uniquement le combiné de votre appareil près de votre oreille lorsqu'il est en mode de conversation normal.
18. Les adaptateurs sont conçus pour être orientés en position verticale ou en position horizontale sur le plancher.
19. N'utilisez que cordon d'alimentation et les piles indiquées dans ce guide d'utilisation.
20. Pour les **PRODUITS À BRANCHER À UNE PRISE DE COURANT**, la prise de courant doit être installée près du produit, afin d'assurer une accessibilité sécuritaire à la prise de courant.
21. En position de montage mural, assurez-vous de monter le socle du téléphone sur le mur en alignant les oeillets avec les goujons de fixation de la plaque murale. Ensuite, faites glisser le socle vers le bas sur les deux goujons de fixation jusqu'à ce qu'il se verrouille en place. Ne fixez l'appareil qu'à des hauteurs ne dépassant pas 2 mètres. Reportez-vous aux instructions complètes dans la section "Handset Installation" à la page 18-22.

22. MISE EN GARDE : Éloignez les petits objets métalliques tels que les broches de l'écouteur du combiné.
23. AVERTISSEMENT : Le produit inclus (ITE) dans ce guide doit être connecté uniquement aux réseaux PoE sans être acheminé vers l'installation extérieure.

## CONSERVEZ CES INSTRUCTIONS

<p>Alimentation électrique</p> 	<p>Adaptateur électrique du chargeur du combiné : 5,0 V CC, 2 A (Numéro de modèle : NBS10B050200VUU)</p> <p>Pile du combiné : Pile au lithium-ion polymère de 3,7 V 1 350 mAh (Numéro de modèle : 573554, Fabricant : Shenzhen EPT Battery Co., Ltd.)</p>
---	---

### MISES EN GARDE

- La pile ne peut pas être soumise à des températures extrêmes hautes ou basses pendant l'utilisation, l'entreposage ou le transport.
- La pile ne peut pas être soumise à une faible pression atmosphérique à haute altitude pendant l'utilisation, l'entreposage ou le transport.
- La pile de ce produit est remplaçable. Il existe un risque d'explosion si la pile n'est pas remplacée correctement.
- Le remplacement d'une pile d'un type incorrect peut entraîner une explosion ou la fuite d'un liquide ou d'un gaz inflammable.
- Évitez de jeter une pile dans le feu ou dans un four chaud, ou d'écraser ou de couper mécaniquement une pile, car cela peut provoquer une explosion.
- Évitez de laisser une pile dans un environnement où la température est extrêmement élevée, ce qui pourrait provoquer une explosion ou une fuite de liquide ou de gaz inflammable.
- Une pile soumise à une pression d'air extrêmement basse peut entraîner une explosion ou une fuite de liquide ou de gaz inflammable.

# Compliance

## FCC part 15

---

This device complies with Part 15 of the FCC rules. Operation is subject to the following two conditions: (1) This device may not cause harmful interference, and (2) this device must accept any interference received, including interference that may cause undesired operation.

This equipment has been tested and found to comply with the limits for a Class A digital device, pursuant to Part 15 of the FCC Rules. These limits are designed to provide reasonable protection against harmful interference when the equipment is operated in a commercial environment. This equipment generates, uses, and can radiate radio frequency energy and, if not installed and used in accordance with the instruction manual, may cause harmful interference to radio communications. Operation of this equipment in a residential area is likely to cause harmful interference in which case the user will be required to correct the interference at the user's expense.

Privacy of communications may not be ensured when using this phone.

Warning: Changes or modifications to this equipment not expressly approved by the party responsible for compliance could void the user's authority to operate the equipment.

To ensure safety of users, the FCC/ISED has established criteria for the amount of radio frequency energy that can be safely absorbed by a user or bystander according to the intended usage of the product.

This product has been tested and found to comply with the FCC/ISED criteria. The handset may be safely held against the ear of the user.

## FCC Part 68

---

Consumer Information:

- a. This equipment complies with Part 68 of the FCC rules and the requirements adopted by the ACTA. On the back or bottom of this equipment is a label that contains, among other information, a product identifier in the format **US:AAAEQ##TXXXX**. If requested, this number must be provided to the telephone company.
- b. An applicable certification jacks Universal Service Order Codes (USOC) for the equipment is provided (i.e., **RJ45C**) in the packaging with each piece of approved terminal equipment.
- c. A plug and jack used to connect this equipment to the premises wiring and telephone network must comply with the applicable FCC Part 68 rules and requirements adopted by the ACTA. A compliant LAN cable (RJ45) and modular plug is provided with this product. An RJ45 jack should normally be used for connecting to the SIP equipment through the LAN cable. See installation instructions for details.
- d. If this equipment causes harm to the telephone network, the telephone company will notify you in advance that temporary discontinuance of service may be required. But if advance notice isn't practical, the telephone company will notify the customer as soon as possible. Also, you will be advised of your right to file a

complaint with the FCC if you believe it is necessary.

- e. The telephone company may make changes in its facilities, equipment, operations or procedures that could affect the operation of the equipment. If this happens the telephone company will provide advance notice in order for you to make necessary modifications to maintain uninterrupted service.
- f. Should you experience trouble with this equipment, please contact  
Snom Technology GmbH  
1 (339) 227-6160 (select option 2)  
for repair or warranty information. If the equipment is causing harm to the telephone network, the telephone company may request that you disconnect the equipment until the problem is resolved.
- g. Please follow instructions for repairing if any (e.g. battery replacement section); otherwise do not alternate or repair any parts of device except specified.
- h. Connection to party line service is subject to state tariffs. Contact the state public utility commission, public service commission or corporation commission for information.
- i. **NOTICE:** If you have specially wired alarm equipment connected to the telephone line, ensure the installation of this product does not disable your alarm equipment.  
If you have questions about what will disable alarm equipment, consult your telephone company or a qualified installer.
- j. This equipment is hearing aid compatible.

**NOTICE:** According to telephone company reports, AC electrical surges, typically resulting from lightning strikes, are very destructive to telephone equipment connected to AC power sources. To minimize damage from these types of surges, a surge arrestor is recommended.

## Industry Canada

---

This Class A digital apparatus complies with Canadian requirements: CAN ICES-3 (A)/NMB-3(A). Cet appareil numérique de la classe A est conforme à la norme CAN ICES-3 (A)/NMB-3(A) du Canada.

This device contains licence-exempt transmitter(s)/receiver(s) that comply with Innovation, Science and Economic Development Canada's licence-exempt RSS(s).

Operation is subject to the following two conditions: (1) this device may not cause interference, and (2) this device must accept any interference, including interference that may cause undesired operation of the device.

Privacy of communications may not be ensured when using this telephone.

The term "IC:" before the certification/registration number only signifies that the Industry Canada technical specifications were met.

This product meets the applicable Innovation, Science and Economic Development Canada technical specifications.

# Introduction

## **About this manual**

---

This user manual provides installation and handset configuration instructions, and detailed instructions for using the M56 SIP DECT Rugged Handset.

See “Viewing handset status” on page 66 for instructions on how to check the software version of your M56 SIP DECT Rugged Handset and/or M500 Dual-cell SIP DECT Base Station.

Please read Important Safety Information on page 5 of this user manual.

Please thoroughly read this user manual for all the feature operations and troubleshooting information necessary to install and operate your handset.

Please refer to the Snom Service Hub at **service.snom.com** for complete configuration instructions.

For customer service or product information, visit our website at **www.snomamericas.com**.

## Product overview

---

The M56 SIP DECT Rugged Handset, combined with the M500 Dual-cell SIP DECT Base Station, is a full-featured SIP endpoint business phone system designed to work with popular hosted IP PBX services and on-premise SIP PBXs. Once you have ordered and configured your PBX service, the handset enables you to make and receive calls as you would with any other business phone.

Up to eight M55 handsets/M56 handsets/M58 desksets can be registered per M500 base station, with up to two M500 base stations connected in dual-cell operation. Each handset/deskset provides calling features such as hold, transfer, conferencing, and speakerphone.

The M500 Dual-cell SIP DECT Base Station supports shared calls among multiple cordless handsets/desksets with a single SIP account. With Shared Call Emulation, the Programmable Feature Keys (PFKs) can be configured as KeyLine type, which enables the keys to be used as for making calls, picking up held calls, and barging in calls.





The features of the M56 SIP DECT Rugged Handset include:

- 2.4" color display
- Speakerphone, Hold and Mute
- Up to 8 SIP accounts per M500 base station
- Up to 8 concurrent calls per M500 base station
- Shared Call Emulation -- Shared call usage on single SIP account among multiple handsets/desksets
- 6 Programmable Feature Keys (PFKs) numbered 1-6 with LEDs
- 3 Soft Keys
- Message waiting alert LED
- 3-way conferencing
- Integrated Bluetooth for headset support
- Corded headset support
- Programmable key for multicast paging
- 400-entry local directory
- 1,000-entry shared directory with entries shared on all registered handsets and desksets
- Antibacterial plastic

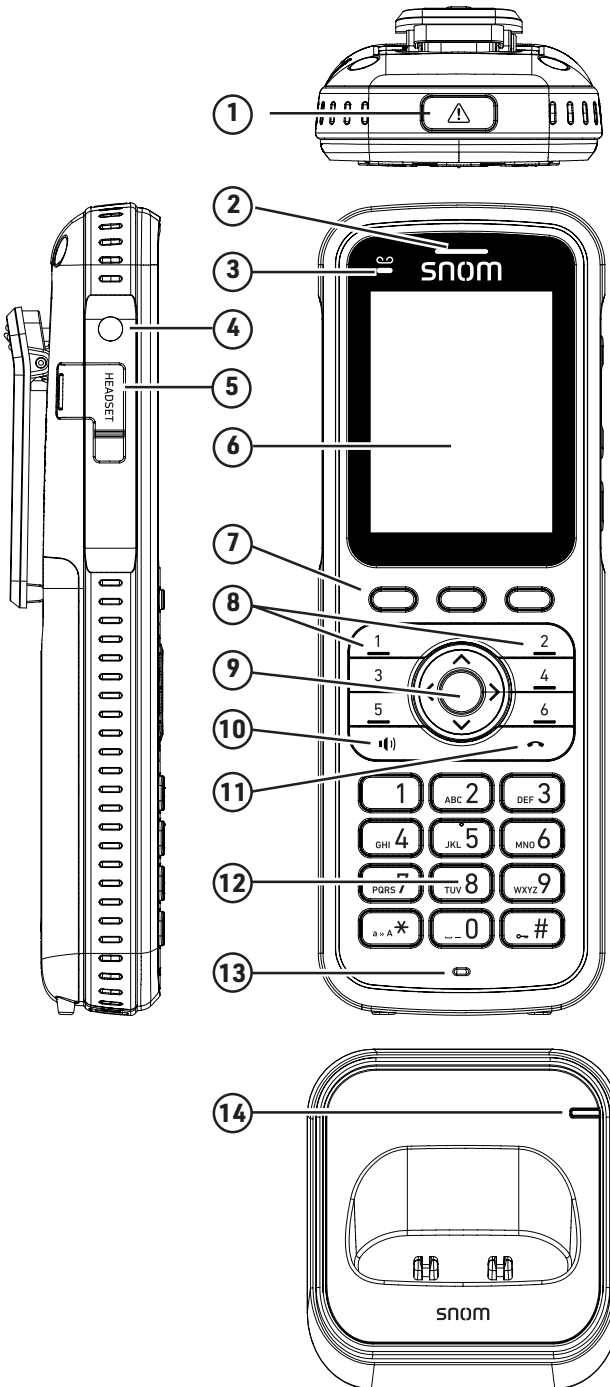
# Quick Reference Guide

## Cordless handset external features



1	Alarm key
2	Earpiece
3	<b>MESSAGE LED</b>
4	Flashlight LED
5	Headset jack
6	Color screen
7	Soft keys
8	Programmable Feature Keys (PFKs) 1-6
9	<b>MENU/Confirm</b> key  and navigation keys    
10	<b>SPEAKER</b> key
11	<b>OFF/Cancel</b> key
12	Alphanumeric keypad
13	Microphone
14	Charge LED

# Quick Reference Guide

## Cordless handset external features

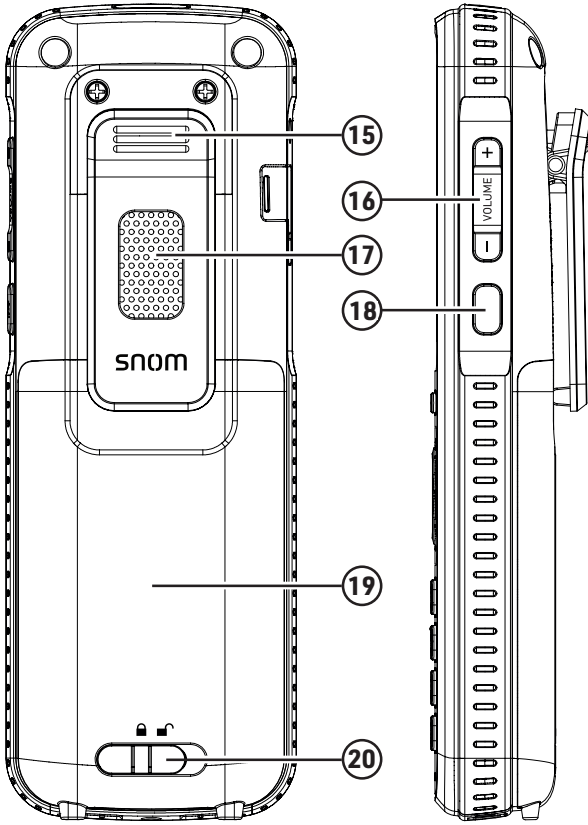

15	Belt clip
16	- <b>VOLUME</b> + key
17	Speaker
18	Programmable key
19	Battery cover
20	Battery cover latch



# Factory Default Programmable Feature Key (PFK) Settings

Your handsets have a factory default configuration where the PFKs (**1 to 4**) are set up to handle calls on a shared line.

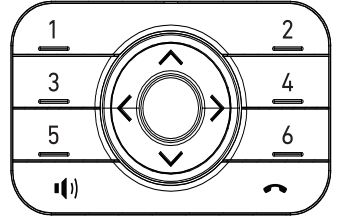

- All handset users can use the shared line via the PFKs.
- The LEDs on the PFKs will be on or flashing to indicate calls in progress across all handsets/desksets.
- A handset user can make a new call, pick up a held shared call, or barge in a shared call by pressing the PFKs.

For more information, see “Using Shared Call Emulation” on page 49.

Please note that the PFKs may be configured differently on your phone system. For example, a PFK might be used for a private line, to turn DND on/off, etc. To see how the PFKs are configured on your handset, press **PFK 1-6** on the idle screen.

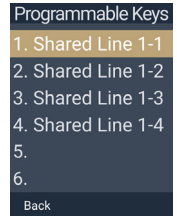

# Handset Installation

This section assumes that your network infrastructure is established and that your IP PBX phone service has been ordered and configured for your location.

Handset installation involves both the handset and the handset charger. The charger is powered using the supplied power adapter. The charger can be placed on a flat surface or mounted on a wall.

Avoid placing the handset and charger too close to:

- Communication devices such as television sets, DVD players, or other cordless telephones
- Excessive heat sources
- Noise sources such as a window with traffic outside, motors, microwave ovens, refrigerators, or fluorescent lighting
- Excessive dust sources such as a workshop or garage
- Excessive moisture
- Extremely low temperature
- Mechanical vibration or shock such as on top of a washing machine or work bench

## Installing the charger

---

Install the charger as shown below.

Plug the power adapter into an electrical outlet not controlled by a wall switch.

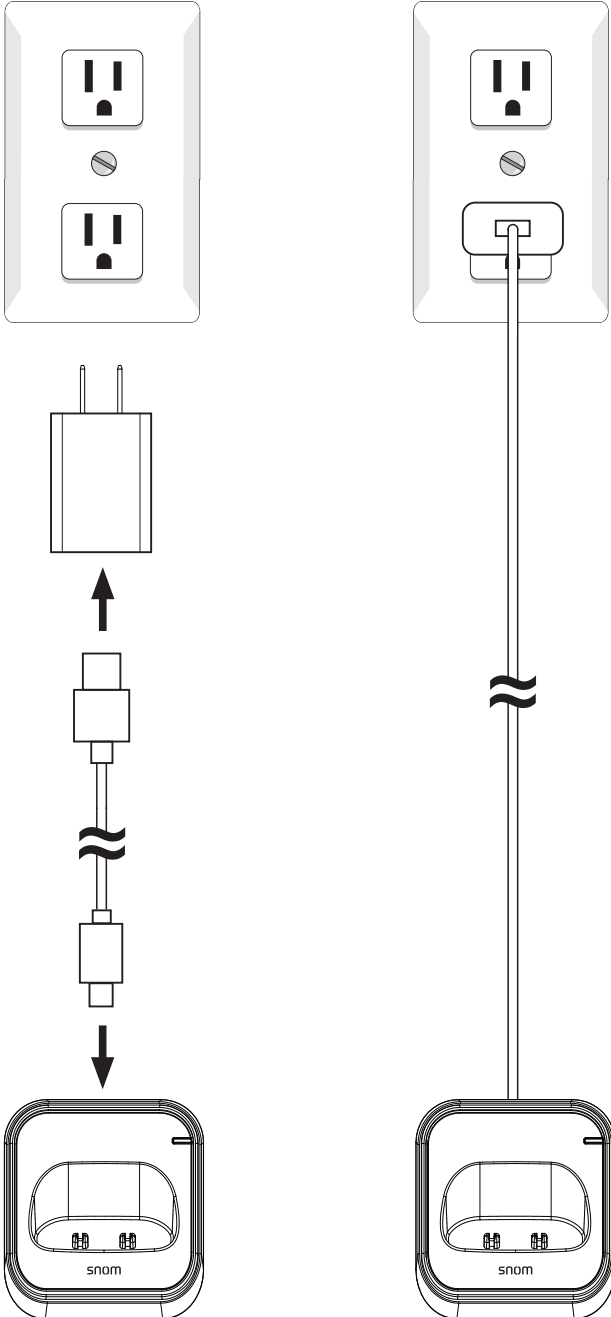



## IMPORTANT INFORMATION



1. Use only the power adapter supplied with this product.  
To order a replacement power adapter, visit our website at [www.snomamericas.com](http://www.snomamericas.com).
2. The power adapter is intended to be correctly oriented in a vertical or floor mount position. The prongs are not designed to hold the plug in place if it is plugged into a ceiling, under-the-table or cabinet outlet.

### Battery installation and charging

Install the battery as shown on the following page. Once you have installed the battery, the screen indicates the battery status (see the table below). If necessary, place the handset in the charger to charge the battery. For best performance, keep the handset in the charger when not in use. The battery is fully charged after 11 hours of continuous charging.

If the screen is blank, you need to charge the handset without interruption for at least 30 minutes to give the handset enough charge to use the telephone for a short time.

When the battery is low, the handset shows a flashing Very low battery icon  or Low battery icon .



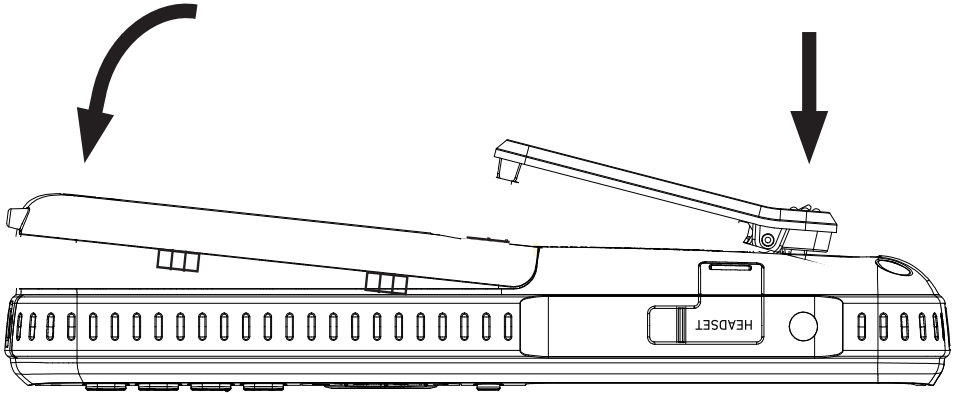
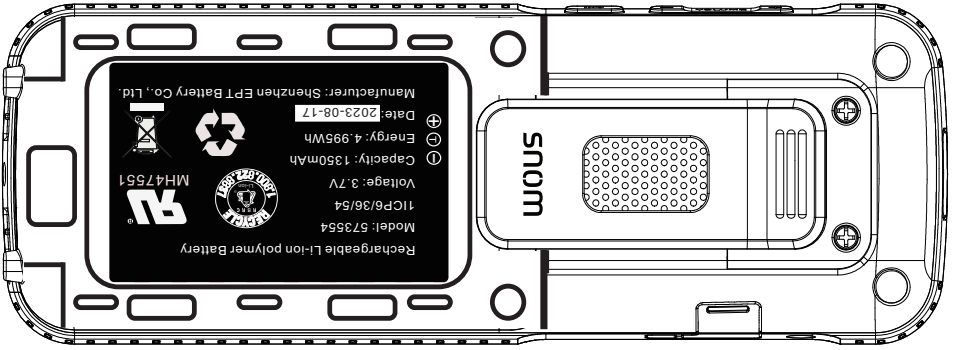

Battery indicators	Battery Status	Action
The screen is blank or Very low battery icon  flashes.	The battery has no or little charge. The handset cannot be used.	Charge without interruption (at least 30 minutes).
Low battery icon  flashes.	Battery has enough charge to be used for a short time.	Charge without interruption (at least 30 minutes).
Full battery icon  appears.	Battery is charged.	To keep the battery charged, place it in the charger when not in use.

## To install the handset battery:

1. Place the top of the battery in the handset battery compartment so that the battery connectors are aligned.
2. Push the bottom of the battery down into the battery compartment.
3. Press down on the belt clip so it lifts away from the handset.
4. Insert the battery cover and align the tabs with the slots.
5. Press down on the battery cover until it clicks into place.
6. Slide the battery cover latch to the locked position. 



7. Charge the handset by placing it face forward in the charger.  
The battery icon indicates the charge status as the battery charges.

	Very low battery. Charging less than 30 minutes.
	Charging less than 30 minutes.
	Charging 30 to 80 minutes.
	Charging 80 minutes to 7 hours.
	Charging more than 7 hours. Fully charged at 11 hours.

### IMPORTANT INFORMATION

- Use only the supplied rechargeable battery or replacement battery (model number 573554). To order a replacement battery, visit our website at **[www.snomamericas.com](http://www.snomamericas.com)**.
- If you do not use the handset for a long time, disconnect and remove the battery to prevent possible leakage.

## Wall mounting the charger

The charger is ready for tabletop use. If you want to mount the charger on a wall, use two 19 mm (3/4 inch) screws and wall anchors to hold the charger in place. Screws and wall anchors are not provided, but are available for purchase at hardware retailers. You might need a professional to install the charger.

### To mount the charger on the wall:

1. Use a pencil to mark the desired positions of the two holes on the wall. Make sure the space between the two holes is 32 mm (1 1/4 inches). Drill two holes in the wall according to the marks.

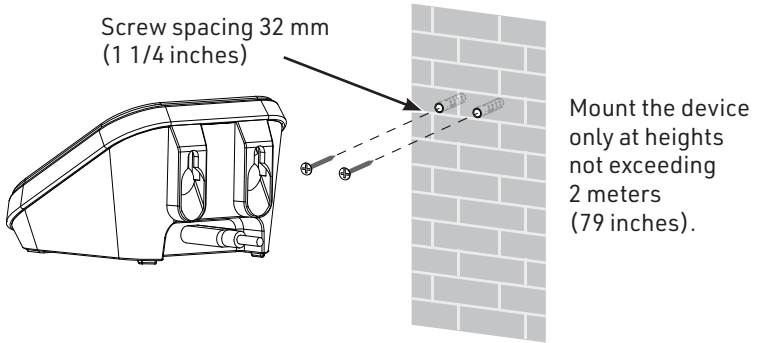

2. If you drill the holes into a stud, go to step 3.

-OR-

If you drill the holes into an object other than a stud, insert the wall anchors (not provided) into the holes and tap gently on the ends with a hammer until the wall anchors are flush with the wall.

3. Insert the screws into the holes and tighten them until only 6 mm (1/4 inch) of the screws are exposed.
4. Align the holes at the back of the charger with the screws on the wall and slide the charger down until it locks into place.

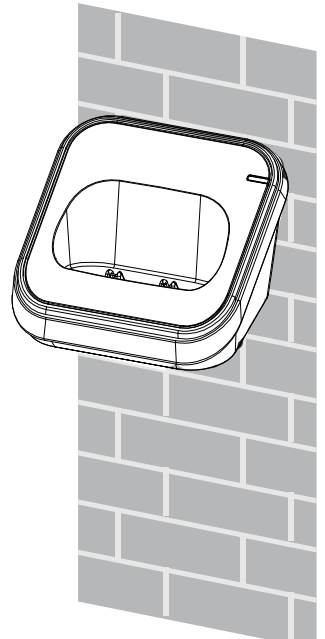

## Adding a corded headset

---

You can use this handset hands-free when you install any industry-standard 3.5 mm corded telephone headset (purchased separately).

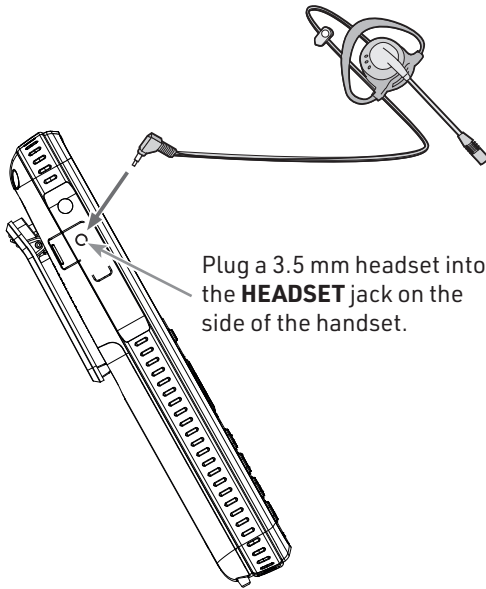

To connect a Bluetooth headset to your handset, refer to the instructions in "Connecting a Bluetooth Headset" on page 63.

## Turning the headset on/off

---

### To turn the headset off:

When the phone is displaying the idle screen, press and hold  for five seconds.

### To turn the headset on:

Place the headset in the charger.

-OR-

Press and hold  for three seconds.



# Handset Registration

The handset must be registered to the base station in order to make and receive calls.

When you power up the handset for the first time, it will attempt to auto-register to the base station. Auto-registration will be successful only if you have set up the M500 configuration file with the handset IPEI, or you have entered the IPEI on the Primary base station's WebUI.

## Auto-registering the handset to the base station

1. Make sure the base station is connected to power and the network.
2. If the handset is displaying the following screen:

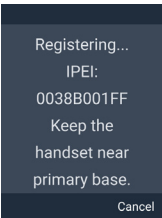

- a. Wait for the handset to auto-register.
- b. If the IPEI has not been set up in the configuration file (provisioned), or the auto-registration is taking too long, press **Cancel**.

3. If the handset is displaying the following screen:

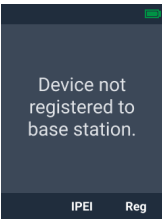

- a. Press **Reg**.  
The handset displays the "Register via" menu.
- b. Press **^** or **v** to scroll to **Auto reg or IPEI input**, and press **Sel**.
- c. Wait for the handset to auto-register.
- d. If auto-registration is taking too long, press **Cancel**.

### If registration is successful:

The handset beeps and displays "Handset registered", and then displays the idle screen.

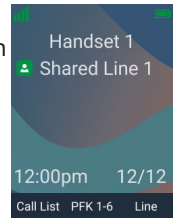

### If registration fails:

The handset displays "Registration failed".

- a. Press **OK**.  
The handset displays "Device not registered to base station."
- b. Press **IPEI** to display the handset's IPEI and serial number. Give these numbers to your phone administrator.
- c. Press **Back**.
- d. To manually register your handset, follow the steps in "Manually registering via the LINK key on base station" on page 27 or "Manually registering via the Web UI" on page 28.



## Registering by entering the handset's IPEI on the Web UI

To register the handset by entering the IPEI on the WebUI, you need to have at least one handset registered in order to get the IP address of the base station; otherwise, you need to look up the IP address from your router that is connected to the M500.

The handset displays the following screen that shows the handset's IPEI.

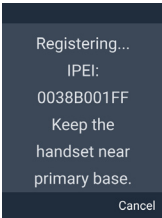

### To register by entering the handset's IPEI on the Web UI:

1. Using the base station's IP address, open the base station's WebUI in a web browser.

**NOTE:** If your phone system is a dual-cell environment, you must open the WebUI of the Primary base station. To check, click **Status** in the WebUI sidebar, and then click **Base Status**. See which base station IP address is set to "Primary" mode. Open the WebUI for this IP address.

2. On the WebUI, click **Status** and then click **Cordless Registrations**.
3. Under **Register Handset**, enter a number for the **Handset ID**. Make sure that you enter a handset ID number that is not already used by another handset or deskset.
4. Enter the handset's **IPEI** (shown on the handset's screen), and then click **Register**.

The handset displays the "Registering... IPEI..." screen.

### If registration is successful:

The handset beeps and displays "Handset registered", and then displays the idle screen.

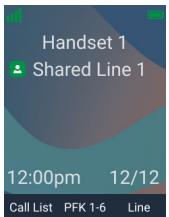

### If registration fails:

The handset displays "Registration failed".

- a. Press **OK**.

The handset displays "Device not registered to base station."

- b. To manually register your handset, follow the steps in "Manually registering via the LINK key on base station" on page 27 or "Manually registering via the Web UI" on page 28.

## Manually registering via the LINK key on base station

1. Make sure the base station is connected to power and the network.

**NOTE:** If your phone system is a dual-cell environment, you can only register the handset to the Primary base station (as indicated by a steady green or slowly flashing red  SIP LED).

2. If the handset is displaying the following screen:

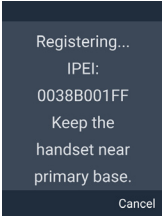

- a. Press **Cancel**.

The handset displays "Registration failed".

- b. Press **OK**.

The handset displays "Device not registered to base station."



3. On the "Device not registered to base station." screen, press **Reg**.

4. With **LINK key on Base** highlighted, press **Sel**.

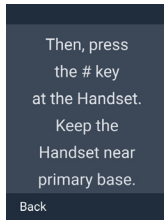
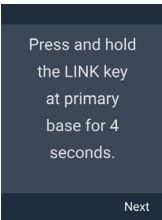
The handset displays the following screens (press **Next** or **Back**):



5. Press and hold the LINK key on the base station for four seconds.

The  (power) and  (SIP) LEDs flash green.

6. Press the # key on the handset to begin registration.

The handset displays "Registering... Please Wait."

### If registration is successful:

The handset beeps and displays "Handset Registered", and then displays the idle screen.

### If registration fails:

The handset beeps and displays "Registration failed".

- a. Press **OK**.

The handset displays "Device not registered to base station."

- b. Make sure the handset is near the base station.

- c. If your phone system is a dual-cell environment, make sure you are registering to the Primary base station. The  SIP LED should be either steady green or slowly flashing red.

- d. Try to register again; go to step 3.

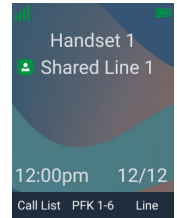

## Manually registering via the Web UI

1. Make sure the base station is connected to power and the network.
2. If the handset is displaying the following screen:

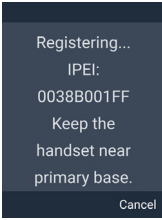

- a. Press **Cancel**.  
The handset displays "Registration failed".
- b. Press **OK**.  
The handset displays "Device not registered to base station."

3. On the "Device not registered to base station." screen, press **Reg**.
4. Press **^** or **v** to scroll to **Manual start on WUI** and press **Sel**.  
The handset displays the following screens (press **Next** or **Back**):

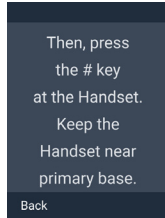
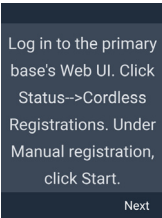

5. Using the base station's IP address, open the base station's WebUI in a web browser.

**NOTE:** If your phone system is a dual-cell environment, you must open the WebUI of the Primary base station. To check, click **Status** in the WebUI sidebar, and then click **Base Status**. See which base station IP address is set to "Primary" mode. Open the WebUI for this IP address.

6. On the WebUI, click **Status** and then click **Cordless Registrations**.
7. Under **Manual registration**, click **Start**.  
The WebUI displays "Success / Registration started".
8. Press the **#** key on the handset to begin registration.  
The handset displays "Registering... Please Wait."

### If registration is successful:

The handset beeps and displays "Handset Registered", and then displays the idle screen

### If registration fails:

The handset beeps and displays "Registration failed".

- a. Press **OK**.  
The handset displays "Device not registered to base station."
- b. Make sure the handset is near the base station.

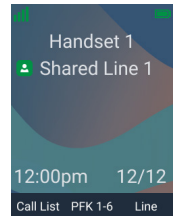

- c. If your phone system is a dual-cell environment, make sure you are registering to the Primary base station. Click **Status** in the WebUI sidebar, and then click **Base Status**. See which base station IP address is set to "Primary" mode. Open the WebUI for this IP address.
- d. Try to register again; go to step 3.

## Deregistering the handset

Before using the handset with a different base station, you must deregister the handset from the base station to which it is currently registered.

### To deregister the handset:

1. Press the **MENU/Confirm** key.
2. Press **▼** and **>** to select  (Settings), then press **OK**.
3. Press **▲** or **▼** to scroll to **User settings**, and press **Enter**.
4. Press **▲** or **▼** to scroll to **Registration**, and press **Enter**.
5. Press **▲** or **▼** to scroll to **Deregistration**, and press **Sel.**  
The "Deregistration" screen appears, showing the list of registered handsets. Your handset is indicated by \*\*.
6. Press **▲** or **▼** to select the handset you want to deregister, and press **Sel.**
7. Enter the PIN and press **OK**. The default PIN is 0000.  
The handset beeps and displays "Handset is deregistered".

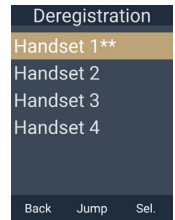
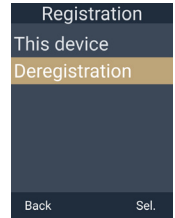









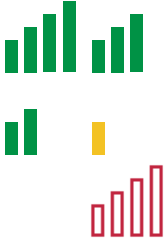
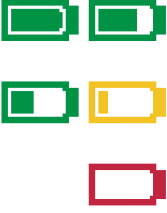









### To deregister the handset using the WebUI:









1. Using the base station's IP address, open the base station's WebUI in a web browser.  
**NOTE:** If your phone system is a dual-cell environment, you must open the Primary base station's WebUI. Click **Status** in the WebUI sidebar, and then click **Base Status**. See which base station IP address is set to "Primary" mode. Open the WebUI for this IP address.
2. On the WebUI, click **Status** and then click **Cordless Registrations**.
3. Under **Cordless Registrations**, click **Deregister** next to the Handset ID you want to deregister.

# Screen icons

The following screen icons indicate your phone's current status:

Icon	Description
	<p>Indicates signal strength, from one bar (weak) to four bars (strong). Flashes when out of range.</p>
	<p>Indicates the battery charge level.</p>
	<p>The microphone is muted.</p>
	<p>The keypad is locked.</p>
	<p>Indicates which of the Programmable Feature Keys (PFK <b>1</b> to <b>6</b>) an active, ringing, or held call occupies. Applicable to both shared calls and private calls. This icon is displayed on the Call List and call screens.</p>
	<p>The ringer is muted.</p>
	<p>The ringer tone is set to "No ringer". Displayed during an incoming call.</p>
	<p>Silent mode is enabled.</p>

Icon	Description
	Vibration is on.
	Corded headset is in use.
	Bluetooth device status - connected headset.
	Call Forward All is on.
	Do Not Disturb is on.
	The speakerphone is active.
	<p>Shared call index number assigned to shared calls. Applicable to shared calls only. This icon is displayed on the Call List and call screens.</p>
	Call History log entry - Dialed call.
	Call History log entry - Received call.
	Call History log entry - Missed call.
	LED flashlight is on.
	Alarm trigger has been detected.

Icon	Description
	Default outgoing line status - Registered.
	Default outgoing line status - Unregistered.
	Default outgoing line status - Disabled.
	Phone configuration has changed or updated. Handset is pending synchronization of the latest configuration in the background.
	Handset is retrieving configuration file in the background.
	Handset is retrieving speed dial configuration in the background.
	Handset is retrieving custom wallpaper in the background.
	Handset is retrieving base directory from the base station in the background.
	Base station is broadcasting latest handset firmware as auto firmware update.



# Using the Handset

This section describes how to use the handset to make calls and answer calls. This section also describes how to put calls on hold, transfer calls, and create conference calls.

## Idle screen

The Idle screen appears after the phone is connected and configured for your SIP PBX service. The Idle screen indicates that you have no active or held calls.

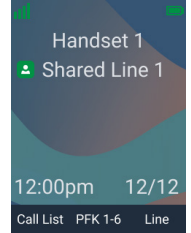

From the Idle screen, you can press:

- **Call list** to view the Call List.  
See "Displaying calls on the Call List" on page 47.
- **Line** to select another account (SIP Account).  
When you make a call, the phone will use this account. See "If you wish to choose a dialing line (account) for the outside call:" on page 35.
- **MENU/Confirm** key to view the main menu - see "Main Menu" on page 34.

## Password warning on the Idle screen

The idle screen will display a warning message if the Administrator Password and/or User Password has not been changed from its default value.

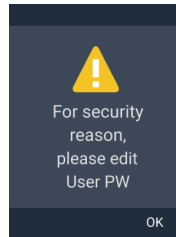
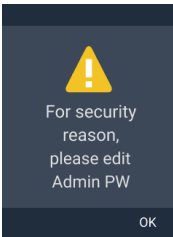

### To temporarily clear the warning message:

- Press **OK**.

The idle screen appears. After 15 minutes, the warning message reappears.

### To permanently clear the warning message:

- Change the User Password in the WebUI. See "Security" on page 84.
- Ask your system administrator to change the Administrator Password.

## Main Menu

---

When your handset is idle, press the **Menu/Confirm** key to display the Main Menu.

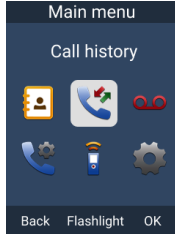

Press the navigation keys     to highlight a menu item, and press **OK**.



**Directory** - see "Using the Directory" on page 56.



**Call history** - see "Using the Call History" on page 59.



**Message** - see "Listening to messages" on page 55.



**Call features** - see "Connecting a Bluetooth Headset" on page 63 and "Setting call waiting" on page 66.



**Intercom call** - see page 36 and 43.



**Settings** - see "Configuring the Handset" on page 66.

## Making calls

You can make calls to any phone number (an outside call), or you can call another handset (an intercom call).



### To make an outside call:

1. Use the keypad to enter the desired number.
  - Press **Del.** if you enter an incorrect digit.
2. Call the number by pressing **Dial**, ) or an idle PFK (assigned as a shared line key).

When the call is answered, the active call screen appears.





**NOTE:** The call screen shows the following icons:

-  icon indicates the call occupies PFK 1.
-  icon indicates shared call index number 1 is assigned to this shared call. This icon is not shown for private calls.

You can also live dial a number by pressing ) or an idle PFK (assigned as a shared line key) to go off hook before entering a phone number on the keypad.

### If you wish to choose a dialing line (account) for the outside call:

1. Press **Line**.
2. Press  or  to select the dialing line (account).
3. Press **Enter**.
4. Use the keypad to enter the desired number, and then press **Dial**.

### To make an outside call using speed dial:

- Press and hold the keypad number key (**0-9**) that matches the speed dial number.

**NOTE:** If the Speed Dial screen appears instead, it means the speed dial number has not been programmed. See "Setting Speed Dial entries" on page 72.

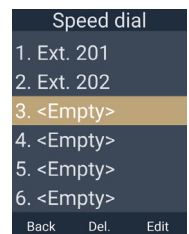



**To make an intercom call to another handset or deskset:**

1. Press the programmable key on the right side of the phone (below the volume keys), and then press **INT**.

-OR-

Press the **MENU/Confirm** key, press  to select  (Intercom Call), then press **OK**.

2. Press  or  to select the handset you wish to call, then press **Dial**.



**Dial** 

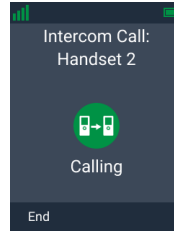

## Answering calls

When there is an incoming call, the handset rings and displays the Incoming call screen.

### To answer a call:

- Press **Ans**,  or the green flashing PFK (assigned as a shared line key):



### To answer an intercom call from another handset or deskset:

- Press **Ans**.

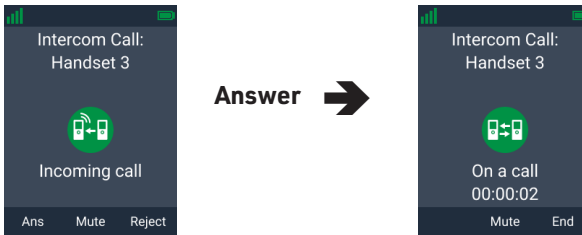

### To mute the ringer:

- Press **Mute**.

The incoming call still appears on your handset display until you answer or reject the call.

If the incoming call is on a shared line, it still appears on your handset display until it is answered by a handset/deskset or rejected by all handsets/desksets.

### To reject a call:



- Press **Reject**.

If the call is on a shared line, the rejected call will continue to ring on other handset/desksets until it is answered or rejected by all handsets/desksets. Your handset will not ring again for the rejected call.

## Answering multiple incoming calls

---

If you have multiple incoming calls, (as indicated by ):

- Press  or  to select the call you want to answer and press **Ans.**

-OR-

Press the green flashing PFK (assigned as a shared line key) for the call you want to answer.

The unanswered call is displayed on a Call waiting screen.

You can choose to answer, mute, or reject this call - see "Call Waiting" on page 39 for more details.

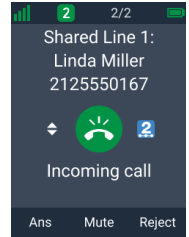

## Ending a call

---

**To end a call:**

- Press  or place the handset in the charger.

## Volume

---

**To adjust the listening volume during a call:**

- Press **VOLUME -** or **+** on the side of the handset.

## Mute

---

The mute function enables you to hear the other party, but the other party cannot hear you.

**To mute your handset's microphone during a call:**

- Press **Mute**.

When your handset's microphone is muted, the handset displays the mute



icon at the top of the screen.

**To unmute your handset's microphone during a call:**

- Press **Unmute**.

## Speakerphone



---

**To turn the speakerphone on/off during a call:**

- Press  to switch between speakerphone and normal handset use.

When the speakerphone is active, the handset displays the speakerphone



icon  at the top of the screen, and the  key is illuminated.

## Corded Headset

---

When the corded headset is active during a call, the handset displays the headset icon



at the top of the screen.

## Bluetooth headset

---

### To switch audio to your Bluetooth headset during a call:

- Press the soft key with your Bluetooth headset name.

### To switch audio back to the speakerphone:

- Press **USE SPK**.

## Call Waiting

---

If you are on a call, and receive an incoming call from an outside number, the handset displays the Call Waiting screen. If you answer the call, your active call will be put on hold.

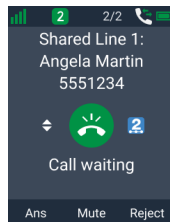



### To answer the incoming call:

- Press **Ans**.

### To ignore the incoming call:

- Press **Ignore**.

If the call is on a shared line, the ignored call will continue to ring on other handset/desksets until it is answered by a handset/deskset or rejected by all handsets/desksets.

The  symbol indicates you can press  or  to switch back to the "Call waiting" screen, where you can still answer or reject the ignored call.

If you end your active call or put it on hold, the ignored call will ring on your handset again.

### To reject the incoming call:

1. Press **Reject**.
2. Press **Yes** on the confirmation screen.

If the call is on a shared line, the rejected call will continue to ring on other handset/desksets until it is answered by a handset/deskset or rejected by all handsets/desksets. Your handset will not ring again for the rejected call.

## Missed Calls

---

If you don't respond to an incoming outside call, the handset displays a missed call alert on the idle screen.

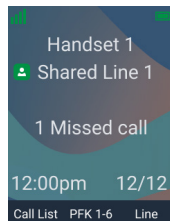

## Putting a call on hold

You can put an outside call on hold by pressing **Hold**. The handset also puts calls on hold automatically when you answer another call, transfer a call, or create a conference. Note that you cannot put an intercom call on hold.

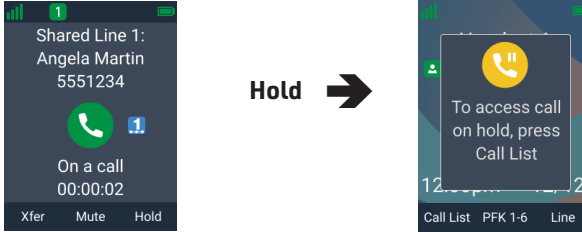

### To take the call off hold:

1. Press **Call List**.
2. If you have multiple calls on hold, press **^** or **∨** to select the call you want to take off hold.
3. Press **Resume**.

If another party puts you on hold, you may see the message **Held by far end**. This message depends on compatibility between phones and PBX types, and may not always appear. You can press **End** to end the call.

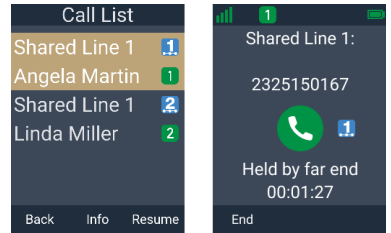

### To make a new call while on hold:

1. When you have a call on hold, use the keypad to enter the number you wish to dial.
2. Call the number by pressing **Dial**, **⏏** or an idle PFK (assigned as a shared line key).



## Putting a call on private hold

---

You can put a shared call on “private hold” to prevent any non-system phones (not M55, M56 or M58) from resuming the held call shared across many SIP devices.

### To put a shared call on private hold:

- Press and hold the **Hold** soft key.

### To take the call off private hold:

1. Press **Call List**.
2. If you have multiple calls on hold, press  or  to select the call you want to take off hold.
3. Press **Resume**.

## Switching between two calls

If you are managing two calls, you can switch between them by one of the following ways:

- Press the red flashing PFK (assigned as a shared line key) of the call you want to pick up

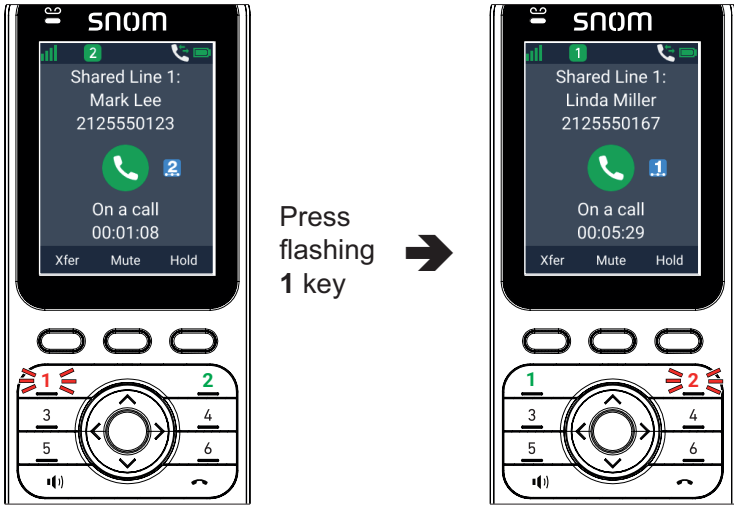

-OR-

1. Press the **MENU/Confirm** key.
2. Press **✓** to scroll to **Call list**, and then press **Select**.
3. Press **Resume**.

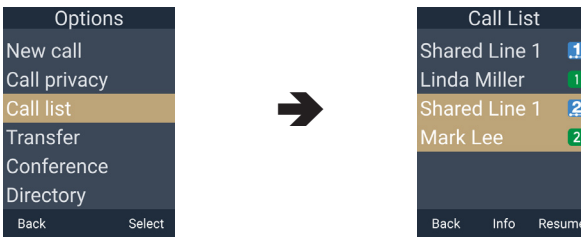

## Paging a group of handsets/desksets

You can page a group of handsets/desksets, and send one-way audio. The receiving handsets/desksets in the group will play an alert tone, and your voice. The receiving handsets/desksets will play the audio as defined in their Auto ans audio settings (see "Setting Auto ans audio" on page 71).



You cannot hear the people you are paging. If you want to have a two-way conversation with a person, make an intercom call instead. For more information, see page 36.



In order for the page to work, the receiving handsets/desksets in the paging group must be idle. Paging groups are defined by your system administrator.

### To page a handset/deskset:

1. Press the programmable key on the right side of the phone (below the volume keys)

-OR-

Press the **MENU/Confirm** key, press  to select  (Intercom Call), then press **OK**. Press **Paging**.

2. Press  or  to select a paging group, and press **Page**.

Your handset displays "Setting up. Please wait for the tone."

When a connection is established, your handset plays a tone and displays "Broadcasting" with a timer.

3. Speak into your handset.
4. To end the page, press **End** or , or place the handset in the charger.

A receiving handset/deskset will not receive the page if:

- It is on an active call
- It is off-hook (deskset)

## Receiving a page

If you receive a page, your handset will play an alert tone and display the message "Paging: Incoming page."

When the connection is established, your handset displays "Broadcasting" with a timer, and you will hear the person paging you. The other person cannot hear you.

### To end the page:

- Press **End** or , or place the handset in the charger.

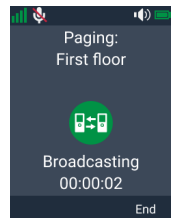
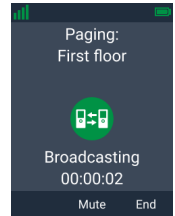
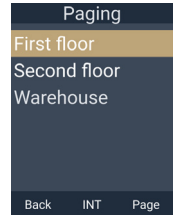

## About Shared Calls

---

A shared line is a line (SIP account) that is configured with account type "Key Line Emulation". A shared line is assigned to more than one handset/deskset within the M500 system. A shared call is an incoming call on a shared line that can be seen and answered by any handset/deskset assigned with the shared line.

A private line is a line (SIP account) that is configured with account type "Standard". A private line is usually assigned to only one handset/deskset in the M500 system, but it can be mapped to more than one handset/deskset. A private call is an incoming call that can only be seen and answered by the handset(s)/deskset(s) assigned with the private line. Once a private call is answered, it is not visible in the Call List to other handsets/desksets that are assigned with the private line.



Active and held shared calls are shown in the Call List. Private calls are only shown in the Call List of the handset/deskset that makes or answers the call. For more information, see "Displaying calls on the Call List" on page 47.

The examples on page 45 and 46 show how to use the Call List to pick up a held shared call, and barge in an active shared call. Each example shows what the screen looks like on two different handsets. In these examples, the handsets are assumed to be configured to their factory default setting with PFKs (**1 to 4**) set up to handle calls on a shared line.

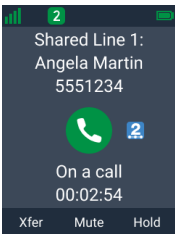
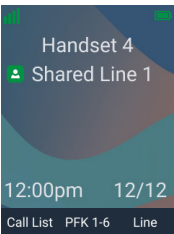
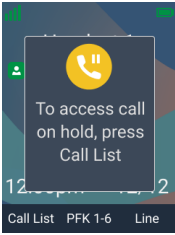
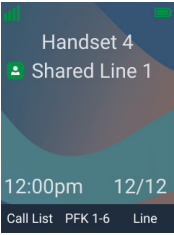
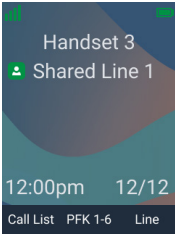
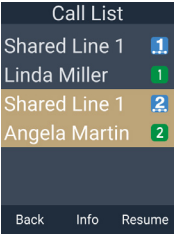
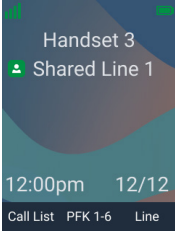
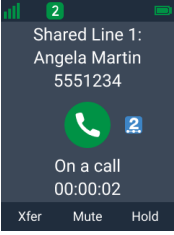
**Example - picking up a held shared call:**

	<b>Alice's handset</b>	<b>Bob's handset</b>
1. Alice is on a call.		
2. Alice presses <b>Hold</b> to put the call on hold.		
3. Alice dials Bob's extension or uses paging to contact Bob. 4. Alice says, "Bob, can you pick up call 2?" 5. Alice ends the call/page with Bob.		
	<b>Alice's handset</b>	<b>Bob's handset</b>
6. Bob presses <b>Call list</b> to display the Call List, and presses <b>✓</b> to highlight call <b>2</b> .		
7. Bob presses <b>Resume</b> to pick up the call. The call is now on Bob's handset.		

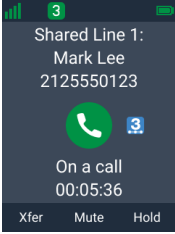
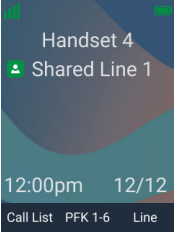
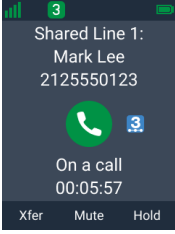
**Example - barging in a shared call:**

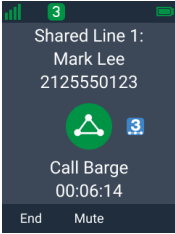
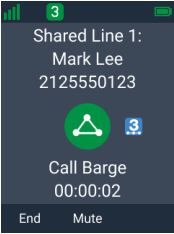
	Alice's handset	Bob's handset
1. Alice is on a call.		
2. Alice presses <b>Hold</b> to put the call on hold. 3. Alice dials Bob's extension or uses paging to contact Bob. 4. Alice says, "Bob, can you join me on call 3?" 5. Alice ends the call/page with Bob. 6. Alice presses <b>Call List</b> to display the Call List, presses ✓ to highlight call 3, and then presses <b>Resume</b> to resume the original call.		
	Alice's handset	Bob's handset
7. Bob presses <b>Call list</b> to display the Call List, and presses ✓ to highlight call 3.		
8. Bob presses <b>Barge</b> to barge in the call. Bob is now in a 3-way call with Alice and the caller on call 3.		

## Displaying calls on the Call List

The Call List enables you to manage your own private calls and shared calls within the system. The Call List displays:

- Shared calls on other handsets/desksets, which can be active, held, or barged-in calls.
- Calls held by your handset whether shared or private.

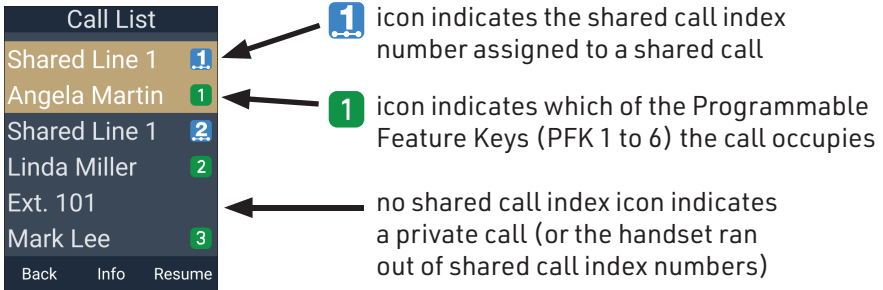





### To view the Call List:

1. If your handset is idle, press **Call List**.

-OR-

If your handset is on an active call, press the **MENU/Confirm** key, then press  to scroll down to **Call List** and press **Select**.

2. If there are multiple calls in the Call List, press  or  to select a call.
3. To display more details about the call, press **Info**. Press  or  to scroll through the other calls in the Call List.

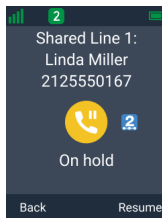
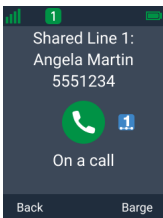

4. To retrieve a call on hold, press **Resume**.
5. To "barge in" on a shared call, press **Barge**.
6. To exit the Call List, press **Back**.

## Barging In

---

You can “barge in” on a shared call in progress on another handset/deskset that shares the account. Barging in establishes a three-way call with two internal parties. Only one barge in party is allowed per active call.

### To barge in on a call:

- Press the steady red PFK (assigned as a shared line key) of the call you want to barge in.  
-OR-
- 1. Press **Call List** to display the Call List.
- 2. Press **^** or **v** to select the call you want to barge in.
- 3. Press **Barge**.

**Note:** The barged call cannot be placed on hold. Only a conference call with two external parties can be placed on hold.

## Call Privacy

---

During an active shared call, you can change Call privacy to allow or disallow barge-in from other handsets/desksets.

- When barge-in is allowed, your handset’s call screen shows “On a call.”
- When barge-in is disallowed, your handset’s call screen shows “Private.”  
If you put the call on hold, other handsets/desksets can pick up the call.

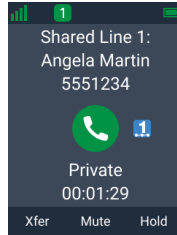
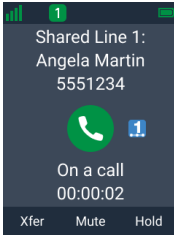

### To change Call privacy during an active shared call:

1. Press the **MENU/Confirm** key.
2. Press **^** or **v** to scroll to **Call privacy** and press **Select**.
3. Press **<** or **>** to select Barge-in as **Disallowed** or **Allowed**, then press **Set**.

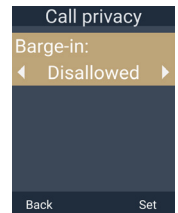



## Using Shared Call Emulation

Your phone is equipped with Shared Call Emulation, where up to six Programmable Feature Keys (PFKs) enable direct interaction with shared calls. The PFKs act like shortcuts to the calls in the Call List.

Shared Call Emulation can be useful for small businesses where incoming calls are answered by a group of people. Handset users can use the PFKs to make new calls, answer incoming calls, pick up calls held by other users, or barge in on other users' calls.

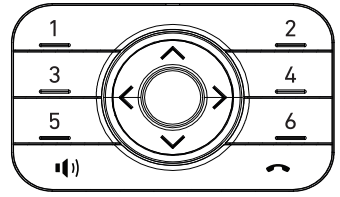







The examples on page 50 and 51 show how to use the PFKs to pick up a held shared call, and barge in an active shared call. Each example shows what the screen and PFK LEDs look like on two different handsets. In these examples, the handsets are assumed to be configured to their factory default setting with PFKs (1 to 4) set up to handle calls on a shared line.

For Shared Call Emulation, the LEDs on the PFKs indicate the status of calls:

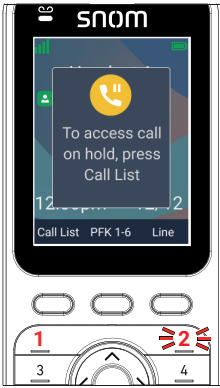

PFK LED	Indicates:	Press the PFK to:
Off	Line is idle	Make a call
Quickly flashing green	Ringing incoming call	Answer the call
Steady green	Call is active on your handset	Put the call on hold
Slowly flashing green	Call is active on your handset, but the far end has put the call on hold	N/A
Slowly flashing red	Call is on hold	Retrieve the held call
Steady red	Shared call is active on another handset/deskset	"Barge in" on the shared call

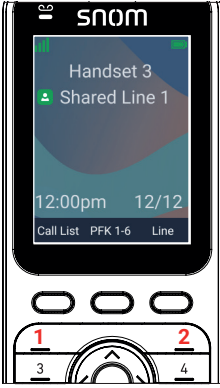
Please note that if a PFK is defined with a different function (such as Do Not Disturb or Call Forwarding), the PFK LED indication will be different.

**Example - picking up a held shared call:**

	Alice's handset	Bob's handset
<p>1. Alice is on a call.</p>		
<p>2. Alice presses <b>Hold</b> to put the call on hold.</p>		
<p>3. Alice dials Bob's extension or uses paging to contact Bob.            4. Alice says, "Bob, can you pick up call 2?"            5. Alice ends the call/page with Bob.</p>		
	Alice's handset	Bob's handset
<p>6. Bob presses PFK <b>2</b> to pick up the call.            The call is now on Bob's handset.</p>		

**Example - barging in a shared call:**

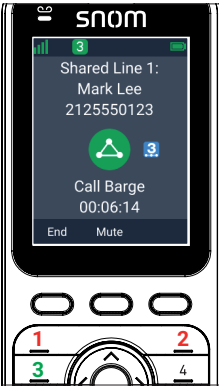
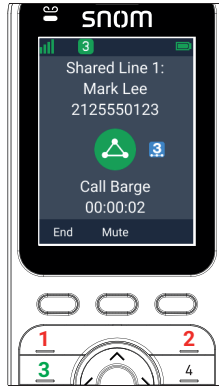
	Alice's handset	Bob's handset
<p>1. Alice is on a call.</p>		
<p>2. Alice presses <b>Hold</b> to put the call on hold.            3. Alice dial Bob's extension or uses paging to contact Bob.            4. Alice says, "Bob, can you join me on call 3?"            5. Alice ends the call/page with Bob and presses <b>PFK 3</b> to resume the original call.</p>		
<p>6. Bob presses PFK <b>3</b> to barge in the call.             Bob is now in a 3-way call with Alice and the caller on call 3.</p>		

## Transferring a call

You can transfer an external call to another party. While you are making the transfer, your call is automatically put on hold. There are three types of transfers:

- **Blind transfer** (default) - Transfer the call immediately without talking to the transfer destination.
- **Announced transfer** - Talk to the transfer destination before transferring the call.
- **Early attended transfer** - Transfer the call while the transfer destination's phone is ringing.

You can also transfer a call to a held call. Note that you cannot transfer intercom calls.

### To transfer a call:

1. During a call, press **Xfer**.

-OR-

Press the **MENU/Confirm** key, then press  to scroll to **Transfer** and press **Select**.

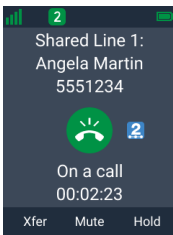



**Xfer** 



2. **To make a Blind transfer:**

- Use the keypad to enter the number of the transfer destination, and press **Xfer**.

-OR-

Press  or  to highlight a held call, and press **Xfer**.

Your handset displays "Call transferred."

-OR-

Press and hold the keypad number key (**0-9**) to dial a speed dial number, and press **Xfer**.



-OR-

Press a PFK assigned to dial a speed dial number, and press **Xfer**.

3. **To make an Announced transfer:**

- a. Use the keypad to enter the number of the transfer destination, and press **Dial**

-OR-

Press  or  to highlight a held call, and press **Sel**.

-OR-

Press and hold the keypad number key (**0-9**) to dial a speed dial number.

-OR-

Press a PFK assigned to dial a speed dial number.

- b. Tell the person you are transferring a call.

- c. Press **Xfer**. Your handset displays "Call transferred."

#### 4. To make an Early attended transfer:

- a. Use the keypad to enter the number of the transfer destination, and press **Dial**.
- b. Press **Xfer** while the transfer destination's phone is ringing.  
Your handset displays "Call transferred."

**Note:** If the transfer destination refuses the call, or if you press **End** to cancel the transfer, your handset displays the original call on hold. Press **Resume** to take the call off hold.

#### Setting up a conference call

---

You can set up a conference call between yourself and two other parties.

##### To set up a conference call with an outside number:

1. During a call, press the **MENU/Confirm** key.
2. Press **✓** to scroll to **Conference** and press **Select**.  
Your call is automatically put on hold.

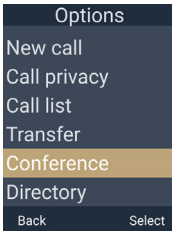

**Select** →

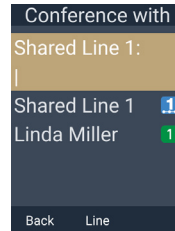

3. Enter the number of the other party you want to join the conference and press **Dial**.

-OR-

Press **^** or **✓** to highlight a held call, and then press **Sel**.

-OR-

Press and hold the keypad number key (**0-9**) to dial a speed dial number.

-OR-

Press a PFK assigned to dial a speed dial number.

4. When the second call is established, press **Conf**.  
The conference begins and the conference screen appears.

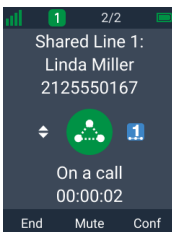

**Conf.** →

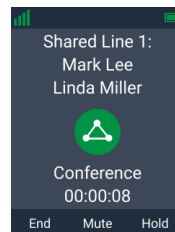

Press **End** to terminate both calls and end the conference.

**Note:** If the conference destination refuses the call, or if you press **End** to cancel the conference, your handset displays the original call on hold. Press **Resume** to take the call off hold.

## Putting a conference call on hold

---

If you press **Hold** during a conference call with two external parties, then each party will be put on hold as a separate call in the Call List.

**Note:** Barged calls cannot be placed on hold. Only a conference call with two external parties can be placed on hold.

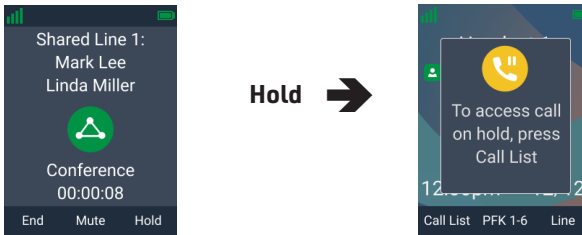

## To re-establish a conference call with the held parties:

1. Take one of the parties off hold.  
See "To take the call off hold:" on page 40.
2. Set up a new conference call (highlight the held call of the other party).  
See "Setting up a conference call" on page 53.

## Listening to messages

---

When you have new messages, the message LED flashes on your handset and the idle screen displays a new messages notification:

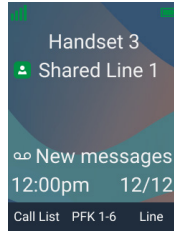



### To listen to your messages:

1. Press the **MENU/Confirm** key, then press  to select  (Message) and press **OK**.

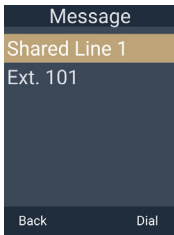
The Message screen appears.



2. Press  or  to highlight the desired dialing line (account) and press **Dial**.  
The handset dials the voicemail access number.
3. Follow the voice prompts to listen to your messages.

## Using the Directory



The handset can access contacts stored in directories. The **Local directory** is only available on your handset. The **Shared directory** is usually maintained by your system administrator, and is available on all handsets. If available, the **Broadsoft** directory enables you to access contacts from directories on a Broadsoft server.

### To view a directory:





1. Press  when the phone is displaying the idle screen  
-OR-

Press the **MENU/Confirm** key, press  to select  (Directory), and then press **OK**.

The Directory menu appears.

2. Press  or  to select the directory you wish to view, and then press **Review** or **Enter**.

**NOTE:** If you selected **Broadsoft** directory, follow the steps described in "To search for a contact in the Broadsoft directory:" on page 57.

3. Press  or  to scroll through contacts. To scroll a page at a time, press **Jump**.
4. Press **Info** to display contact details.
5. Press  or  to scroll through contacts while displaying contact details.
6. To exit the directory, press .

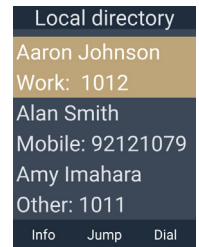
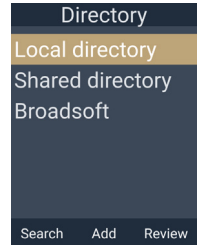

### To call a contact:

When displaying contact details, you can call a contact in the following ways.

#### Dial the phone number in the contact:

1. Press **Type** to cycle through work, mobile, and other numbers.
2. Press **Dial**.

#### Edit the phone number before dialing:

1. Press the **MENU/Confirm** key.
2. With **Edit dial** highlighted, press **Select**.
3. Edit the number as required, and then press **Dial**.

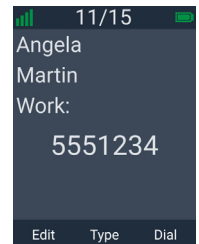



### To sort contacts in the Local or Shared directory:

1. When viewing a directory, press the **MENU/Confirm** key.
2. Press **^** or **v** to select **Sort by first name** or **Sort by last name**, and then press **Select**.

NOTE: You cannot sort contacts in the Broadsoft directory.

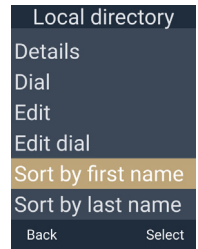

### To search for a contact in the Local or Shared directory:

1. On the Directory menu, press **^** or **v** to select the directory you wish to view, and then press **Search**.

NOTE: If the directory is sorted by first name, you will search by first name. If the directory is sorted by last name, you will search by last name.

2. Enter a few letters of the name, and then press **Search**.

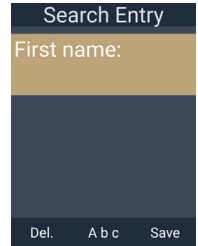

### To search for a contact in the Broadsoft directory:

1. On the Broadsoft directory menu, press **^** or **v** to select the Broadsoft directory you wish to view, and then press **Search**.

2. Enter a few letters of the **First or last name**.

**NOTE:** You can enter the wildcard character **\*** before and/or after the search string to specify a match with any characters.

For example, **Bo\***, **\*mith**, **\*mi\***.

3. Press **Search**.

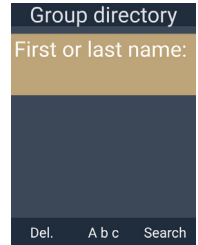
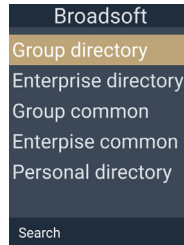

### To save a Broadsoft contact to the Local directory:

1. When displaying the list of contacts in the Broadsoft directory, press **^** or **v** to select the contact you wish to save, and then press **Info**.

2. Press the **MENU/Confirm** key, press **^** or **v** to select **Save**, and then press **Select**.

3. With **Local directory** selected, press **Select**.

4. Make any necessary changes, if desired.

5. To save the contact to the Local directory, press **Save**.

To cancel without saving, press **End Call**.

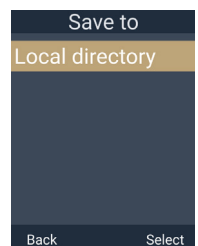
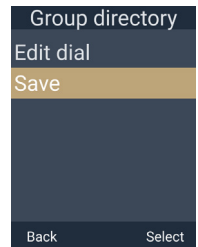

You can add, edit and delete contacts in the Local directory only.

### To add a contact to the Local directory:

1. On the Directory menu, press **^** or **✓** to select **Local directory**, and then press **Add**.
2. Use the keypad to enter the First name, Last name, Work, Mobile, and Other phone numbers. Press **✓** after entering each item.
  - Press **<** or **>** to move the cursor.
  - Press **Del.** to delete a character.
3. Press **<** or **>** to choose the Ringer tone, then press **✓**.
4. Press **<** or **>** to choose the Dial line (account).
5. To save the contact, press **Save**. To cancel without saving, press .

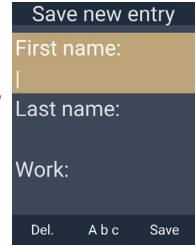

### To edit a contact in the Local directory:

1. When viewing the Local directory, press **^** or **✓** to select the contact.
2. Press the **MENU/Confirm** key, press **^** or **✓** to select **Edit**, and then press **Select**.
3. Press **^** or **✓** to select an item to edit.
4. Use the keypad to change the First name, Last name, Work, Mobile, and Other phone numbers.
  - Press **<** or **>** to move the cursor.
  - Press **Del.** to delete a character.
5. Press **<** or **>** to change the Ringer tone and Dial line (account).
6. When you are done editing, press **Save**. To cancel without saving, press .

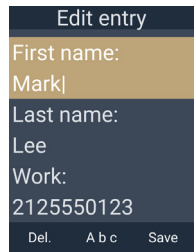

### To delete a contact in the Local directory:

1. When viewing the Local directory, press **^** or **✓** to select the contact.
2. Press the **MENU/Confirm** key, press **^** or **✓** to select **Delete**, and then press **Select**.
3. Press **Yes** on the delete confirmation screen.

### To delete all entries in the Local directory:

1. When viewing the Local directory, press the **MENU/Confirm** key, press **^** or **✓** to select **Delete all**, and then press **Select**.
2. Press **Yes** on the delete all confirmation screen.

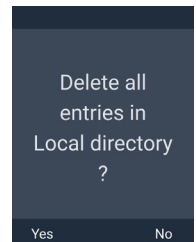

## Using the Call History





The Call History contains lists of your missed calls, received calls, and dialed calls. You can dial the number of a call saved in the list, or save the number to the Local directory.

### To view the Call History:

1. Press  when the phone is displaying the idle screen  
-OR-

Press the **MENU/Confirm** key. With  (Call History) highlighted, press **OK**.

The Call History menu appears.



2. Press  or  to select **Missed calls**, **Received calls** or **Dialed calls**, and then press **Enter**.
3. Press  or  to scroll through the list of calls. To scroll a page at a time, press **Jump**.

The list of calls shows an index number of the call, caller's name/number, time and date.

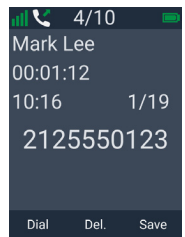
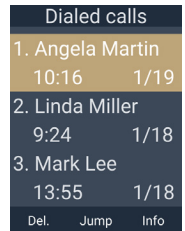
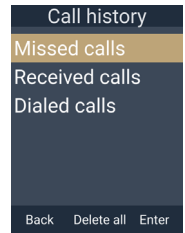

4. Press **Info** to display call details.

The call details screen shows the caller's name, number, call duration, time, and date. The top of the screen shows the index number of the call, number of calls in the list, and an icon indicating the type of call.



5. Press  or  to scroll through calls while displaying call details.
6. To exit Call History, press .



### To call a number in the list:

When displaying the list of Missed calls, Received calls or Dialed calls, press  or  to select a call. You can dial the number in the following ways.

#### Dial the phone number of the call:







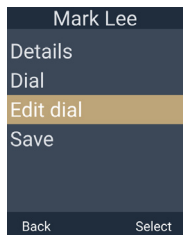



- Press **Info**, and then press **Dial**.

#### Edit the phone number before dialing:

1. Press the **MENU/Confirm** key.
2. Press  or  to select **Edit dial**, and then press **Select**.
3. Edit the number as required, and then press **Dial**.



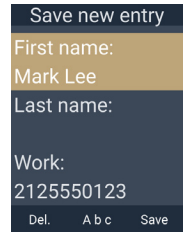

### To save a number to the Local directory:

1. When displaying the list of Missed calls, Received calls or Dialed calls, press  or  to select a call.
2. Press the **MENU/Confirm** key, press  or  to select **Save**, and then press **Select**.
3. OPTIONAL: To edit the details in the contact you are saving:
  - Press  or  to select an item to edit.
  - Use the keypad to edit the First name, Last name, Work, Mobile, and Other phone numbers.
    - Press  or  to move the cursor.
    - Press **Del.** to delete a character.
  - Press  or  to change the Ringer tone and Dial line (account).
4. To save the contact to the Local directory, press **Save**. To cancel without saving, press .



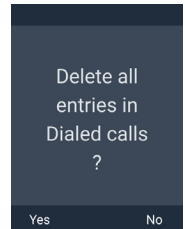

### To delete entries:

1. When displaying the list of Missed calls, Received calls or Dialed calls, press  or  to select a call.
2. Press **Delete**.



### To delete all entries:

1. In the Call History menu, press  or  to select **Missed calls**, **Received calls** or **Dialed calls**, and then press **Delete all**.
2. Press **Yes** on the delete all confirmation screen.

## Locking the keypad

You can lock the keypad on your handset to prevent accidental dialing. If you receive an incoming call, intercom call or page, the keypad will temporarily unlock until the handset is idle again. You must unlock the keypad in order to dial a number or browse the menu screens.

### To lock the keypad:

- Press and hold the # key when the handset is idle.

The  icon at the top of the screen indicates the keypad is locked.

### To unlock the keypad:

- Press and hold the # key.

Note: If you press **Unlock** or any other key, the handset will display unlocking instructions.

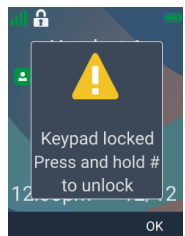

## Using the flashlight

---

The LED on the side of your handset can be used as a flashlight.

If the flashlight is on, the  icon is displayed at the top of the idle screen.

### To turn the flashlight on or off:

- Press a PFK that is configured to turn the flashlight on/off.  
-OR-

Press the **Menu/Confirm** key, and then press **Flashlight** (when the handset is idle OR during predial, active call, transfer setup or conference call setup).

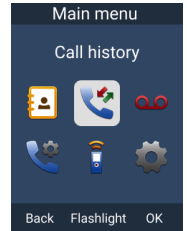



## Emergency alarm

Your M56 handset supports an emergency alarm feature. Depending on how your system is configured, one or more of the following alarm events could trigger the emergency alarm. Ask your administrator which of these alarm events are configured for your system.

- **Alarm key** - Press and hold the alarm key at the top of the handset for 1.5 seconds.
- **Man down** - Handset is in a horizontal position (0-15 degrees) with no movement after a specified amount of time.
- **Running** - Swing or shake the handset with frequency greater than 1.5 Hz in any direction after a specified amount of time.
- **No movement** - Handset is in a steady position (any angle) with no continuous movement after a specified amount of time.

The following steps describe the sequence of events that occurs after an Alarm event triggers the emergency alarm.

1. If Trigger Delay is configured, the  icon appears on the screen, and the alarm is delayed for a specified number of seconds.
2. If a Pre-alarm Delay is configured, the handset displays "Alarm button detected. Alarming in X seconds..." (where X is the Pre-alarm Delay time in seconds).
3. If Howling is enabled, the handset emits a continuous loud alarm sound.
4. If Stop Pre-alarm is enabled, you can cancel the alarm by pressing **Cancel** or . The handset displays "Alarm is paused. Cancel alarm?" Press **Yes** or  to cancel the alarm.
5. After the Pre-alarm Delay time has elapsed, the handset will do one of the following (based on your system configuration):
  - Call a specified telephone number.
  - Make an intercom call to a specified handset/deskset.
  - Page a specified paging group.

If Howling is enabled, the handset stops emitting the alarm sound at this point.

6. If Stop Alarm is enabled, you can cancel the call/intercom/page by pressing **End**.

**NOTE:** The emergency alarm settings are configured on the base station, and cannot be changed or configured on the handset.

For more information about how the emergency alarm feature is configured for your system, ask your administrator.

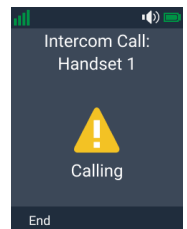
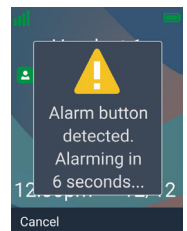
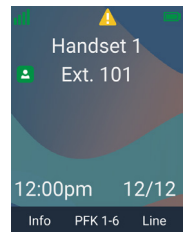

# Connecting a Bluetooth Headset

You can connect a Bluetooth headset to your handset. You can only connect one Bluetooth headset at a time.

## Opening the Bluetooth menu

The Bluetooth menu enables you to select Bluetooth headset and connect it to your handset. In order to open this menu, Bluetooth must be turned On.

### To open the Bluetooth menu:

1. Press the **MENU/Confirm** key.
2. Press **▼** and **<** to select  (Call features), then press **OK**.
3. With **Bluetooth** highlighted, press **OK**.
4. If the Bluetooth On/Off screen appears, press **<** or **>** to choose On, then press **Set**.

The Bluetooth menu appears.

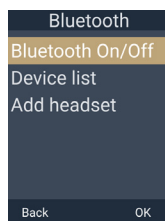

### To turn off Bluetooth Mode:

1. On the Bluetooth menu, with **Bluetooth On/Off** highlighted, press **OK**.
2. Press **<** or **>** to choose Off, then press **Set**.
3. Press **Back**.

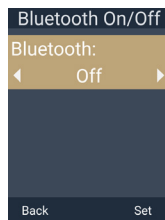

## Adding a Bluetooth headset to the Device list

1. On the Bluetooth menu, press **▲** or **▼** to scroll to **Add headset**, and press **OK**.  
If the handset displays "<device name> already paired. Replace it by a new Bluetooth device?", press **Yes** to continue.
2. Follow the instructions displayed on the handset screen, then press **Next**.
3. Follow the next set of instructions displayed on the handset screen, then press **Next**.

The handset displays "Searching for Bluetooth headset..."

### If the search fails:

The handset displays "Add device failed".

### If the search is successful:

The handset displays the Headset found screen with a list of found devices.

- a. Press **▲** or **▼** to highlight the device you want, then press **Select**.
- b. If you are prompted to enter a PIN, enter the headset PIN and then press **OK**.

The handset displays "Adding <device name> to the device list..."

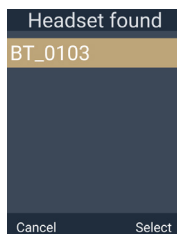

### If adding the device is successful:

The handset displays "<device name> is added and connected to this phone".

Press  to return to the idle screen.

On the idle screen, the Bluetooth icon  indicates the headset is connected.

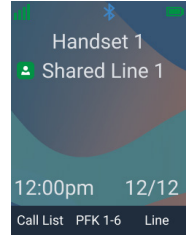

### If adding the device fails:

The handset displays "<device name> is added to the device list".

The handset displays "Please use the Bluetooth device to connect to this phone".

## Using the Device list

The device list displays a device (Bluetooth headset) that has been previously connected to the handset. From this list, you can connect/disconnect/rename the Bluetooth headset, or remove it from the Device list.

### To open the Device list:

- On the Bluetooth menu, press  or  to scroll to **Device list**, then press **OK**.

The Device list appears.

If the Device list is empty, follow the instructions in "Adding a Bluetooth headset to the Device list" on page 63.

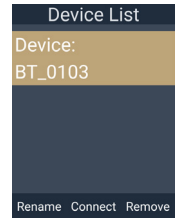

### To connect a Bluetooth headset:

- On the Device list, press **Connect**.

The handset displays "Connecting <device name> to this phone".

### If connecting is successful:

The handset displays "Headset setup is completed. Device is connected."

The handset displays the Bluetooth menu. Press  to return to the idle screen.

On the idle screen, the Bluetooth icon  indicates the headset is connected.

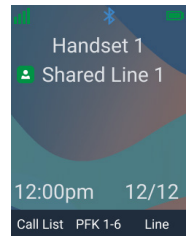

### If connecting fails:

The handset displays "Connection failed".

### To disconnect a Bluetooth headset:

- On the Device list, press **Discon't**.

The handset displays "Disconnecting device..."

The handset displays "Device disconnected."



### To rename a connected Bluetooth headset:

1. On the Device list, press **Rename**.
2. Use the keypad to enter the new device name.
  - Press **<** or **>** to move the cursor.
  - Press **Del.** to delete characters.
3. To save your changes, press **OK**.

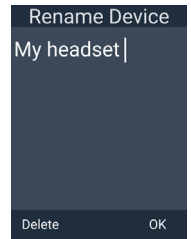

### To remove a device from the Device list:

1. On the Device list, press **Remove**.  
The handset displays "Remove <device name> from Paired list?"
2. Press **Yes**.  
The handset displays "Please wait".  
The handset displays "<device name> is removed from the Paired list".

# Configuring the Handset

You can configure the phone using one of two methods:

1. The **Call Features** and **User settings** menus on the handset.
2. The WebUI, which you access using your Internet browser.

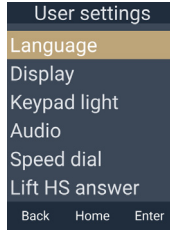
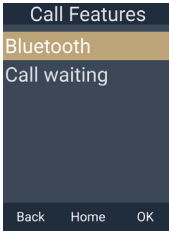







This section describes settings you can change using your handset. For information about settings you can change on the WebUI, see “WebUI” on page 74.

## Setting call waiting

When call-waiting alerts are enabled, you will hear a call waiting tone and an alert will display on-screen whenever you receive an incoming call during an active call.

### To turn call-waiting alerts on or off:

1. Press the **MENU/Confirm** key.
2. Press  and  to select  (Call features), then press **OK**.
3. Press  or  to scroll to **Call waiting** and press **OK**.
4. Press  or  to choose On, Off or Tone off.
5. Press **Set**.

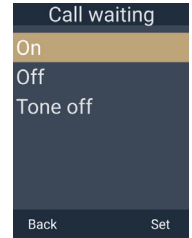





**NOTE:** Tone off is the same as On, except the call waiting tone is muted.

## Viewing handset status

In the Status menu, you can view the IP address of your base station, software version of your handset, and registration status of your SIP accounts. You may need this information for troubleshooting purposes.

### To view the Status menu:

1. Press the **MENU/Confirm** key.
2. Press  and  to select  (Settings), then press **OK**.
3. With **Status** highlighted, press **Enter**.
4. Press  or  to scroll to either **Network**, **Line**, or **Product Info**, and press **Enter**.

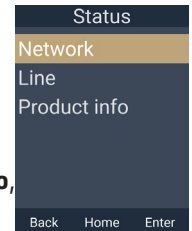

### To view the IP address of your base station:

1. On the **Status** menu, with **Network** highlighted, press **Enter**.
2. Press **^** or **v** to select IPv4 or IPv6, and press **Enter**.
3. Press **v** to scroll down to view the IP address.

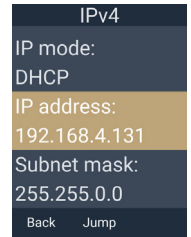

### To view the firmware version of your handset / base station:

1. On the **Status** menu, press **^** or **v** to scroll to **Product Info** and press **Enter**.
2. Press **^** or **v** to select This device or Base/Cell and press **Enter**.
3. Press **v** to scroll down to view the firmware version.



### To view the line status of your handset:

1. On the **Status** menu, press **^** or **v** to scroll to **Line** and press **Enter**.

The top of the screen displays "Loading... (x/48)" while your handset loads assigned lines.

2. Press **^** or **v** to select a line and press **Enter**.
3. Press **^** or **v** to scroll through the information about the line.

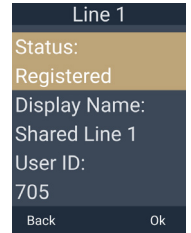
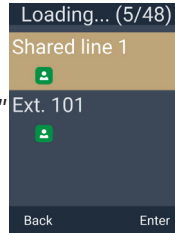

### Setting the language

1. Press the **MENU/Confirm** key.
2. Press **v** and **>** to select  (Settings), then press **OK**.
3. Press **^** or **v** to scroll to **User settings**, and press **Enter**.
4. With **Language** highlighted, press **Enter**.
5. Press **^** or **v** to choose the desired language.
6. Press **Set** to save, or press **Back** to cancel.

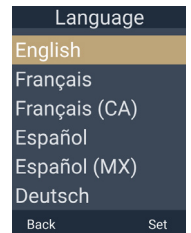

## Setting the display options

---

You can configure the display options on the handset screen – backlight, screensaver, power save timeout, wallpaper and display theme.

### To change the display options:

1. Press the **MENU/Confirm** key.
2. Press **▼** and **➤** to select  (Settings), then press **OK**.
3. Press **▲** or **▼** to scroll to **User settings**, and press **Enter**.
4. Press **▲** or **▼** to scroll to **Display**, and press **Enter**.
5. Press **▲** or **▼** to select a display option:
  - **Backlight On** : press **◀** or **➤** to choose Low, Mid, or High.
  - **Backlight Idle** : press **◀** or **➤** to choose Off, Low, Mid, or High.
  - **Timeout** : press **◀** or **➤** to choose the backlight timeout (in seconds).
  - **Screensaver** : press **◀** or **➤** to choose Off, On (1 min), or On (2 min).
  - **Call Power Save** : press **◀** or **➤** to choose Disabled or Enabled.
  - **Wallpaper** : press **◀** or **➤** to choose a wallpaper.
  - **Theme** : press **◀** or **➤** to choose a display theme.
6. Press **Set** to save, or press **Back** to cancel.



## Setting the keypad light

---

1. Press the **MENU/Confirm** key.
2. Press **▼** and **➤** to select  (Settings), then press **OK**.
3. Press **▲** or **▼** to scroll to **User settings**, and press **Enter**.
4. Press **▲** or **▼** to scroll to **Keypad light**, and press **Enter**.
5. Press **◀** or **➤** to choose Disabled or Enabled.
6. Press **Set** to save, or press **Back** to cancel.

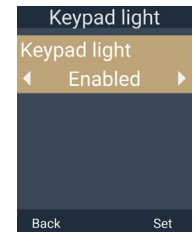









## Setting Silent Mode

If Silent Mode is enabled:

- The handset will not play the sounds of the ringer, confirmation tone, notification tone, key tone, and end of list tone.
- The  icon is displayed at the top of the handset screen.

### To set Silent Mode:



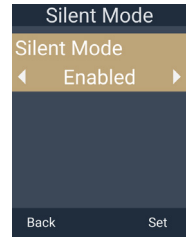













1. Press the **MENU/Confirm** key.
2. Press  and  to select  (Settings), then press **OK**.
3. Press  or  to scroll to **User settings**, and press **Enter**.
4. Press  or  to scroll to **Audio**, and press **Enter**.
5. With **Silent Mode** highlighted, press **Enter**.
6. Press  or  to choose Disabled or Enabled.
7. Press **Set** to save, or press **Back** to cancel.



## Setting the ringer tone and volume

**TIP:** Fast way to set ringer volume: When phone is idle, press **VOLUME -** or **+** on the side of the handset to choose volume level, and then press **Set**.

### To set the ringer tone and volume:

1. Press the **MENU/Confirm** key.
2. Press  and  to select  (Settings), then press **OK**.
3. Press  or  to scroll to **User settings**, and press **Enter**.
4. Press  or  to scroll to **Audio**, and press **Enter**.
5. Press  or  to scroll to **Ringers**, and press **Enter**.
6. To change the ringer volume:
  - a. With **Ringer Volume** highlighted, press **Enter**.
  - b. Press  or  to change the ringer volume level as desired, or press **Off** to turn the ringer off.
  - c. Press **Set** to save, or press **Back** to cancel.
7. To change the ringer tone:
  - a. Press  or  to scroll to **Ringer Tone** and press **Enter**.
  - b. Press  or  to select Intercom ringer or a dialing line (account), then press **Enter**.
  - c. Press  or  to select a ringer tone.
  - d. Press **Set** to save, or press **Back** to cancel.

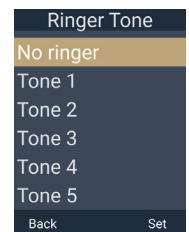
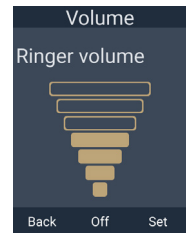



















## Setting the vibration

You can enable the handset to vibrate or vibrate and ring when there is an incoming call. Vibrate then ring will vibrate the handset for the first 10 seconds, then ring. You can also set the vibration level (intensity), and choose an intermittent vibration (2s on, 0.8s off) or continuous vibration. If silent mode or ringer off is enabled, or the ringer volume is set to no ringer, the handset will vibrate without the ringer.

If vibration is on, the  icon is displayed at the top of the screen.

### To set the vibration:

1. Press the **MENU/Confirm** key.
2. Press  and  to select  (Settings), then press **OK**.
3. Press  or  to scroll to **User settings**, and press **Enter**.
4. Press  or  to scroll to **Audio**, and press **Enter**.
5. Press  or  to scroll to **Ringers**, and press **Enter**.
6. Press  or  to scroll to **Vibration**, and press **Enter**.
7. Press  or  to select a vibration setting:
  - **Mode**: press  or  to choose Off, Vibrate only, Vib then ring or Vib and ring.
  - **Level**: press  or  to choose Low, Mid or High.
  - **Scheme**: press  or  to choose Intermittent or Continuous.
8. Press **Set** to save, or press **Back** to cancel.

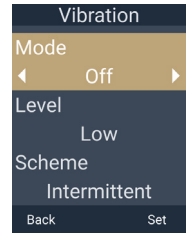

**NOTE:** Vibration options are related to enable/disable ringer, and there is interaction between them.

- If "Vibrate only" is selected, "Silent Ringer" (PFK) option would be enabled (→ mute ringer during incoming call).
- If "Vibrate then/and Ring" is selected, "Silent Ringer" (PFK) option would be disabled.
- If "Vibrate only" is selected, and user selects Ringer Volume (not equal to zero) to enable ringer, Vibration mode would change to "Vibrate then Ring".

## Setting the advisory tones

---

You can enable or disable the advisory tones the handset makes when the battery is low, the link to the base is lost, and when you press a key on the handset.

### To set the advisory tones:

1. Press the **MENU/Confirm** key.
2. Press **▼** and **➤** to select  (Settings), then press **OK**.
3. Press **▲** or **▼** to scroll to **User settings**, and press **Enter**.
4. Press **▲** or **▼** to scroll to **Audio**, and press **Enter**.
5. Press **▲** or **▼** to scroll to **Advisory Tones**, and press **Enter**.
6. Press **▲** or **▼** to select an advisory tone:
  - **Low Batt. Tone** : press **<** or **>** to choose Disabled or Enabled.
  - **Link Lost Tone** : press **<** or **>** to choose Disabled or Enabled.
  - **Key Tone** : press **<** or **>** to choose Disabled or Enabled.
7. Press **Set** to save, or press **Back** to cancel.

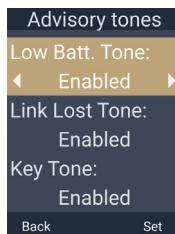

## Setting Auto ans audio

---

When your handset auto answers a page, the audio will be played from the source defined by the Auto ans audio setting.

### To set auto answer audio:



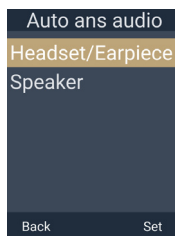





1. Press the **MENU/Confirm** key.
2. Press **▼** and **➤** to select  (Settings), then press **OK**.
3. Press **▲** or **▼** to scroll to **User settings**, and press **Enter**.
4. Press **▲** or **▼** to scroll to **Audio**, and press **Enter**.
5. Press **▲** or **▼** to scroll to **Auto ans audio**, and press **Enter**.
6. Press **▲** or **▼** to select Headset/Earpiece or Speaker.
7. Press **Set** to save, or press **Back** to cancel.



## Setting Speed Dial entries

The speed dial feature enables you to program up to ten numbers that you dial frequently. To dial a speed dial number, press and hold the keypad number key that matches the speed dial number.



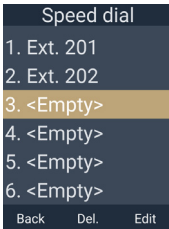

### To program a Speed Dial number:

1. Press the **MENU/Confirm** key.
2. Press  and  to select  (Settings), then press **OK**.
3. Press  or  to select **User Settings**, and then press **Enter**.
4. Press  or  to select **Speed dial**, and then press **Enter**.
5. Press  or  to select an empty slot, then press **Add**.

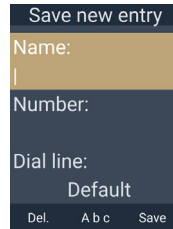





Add 



6. Use the keypad to enter a name, and then press .
  - Press **Del.** to delete characters.
7. Use the keypad to enter a number, and then press .
8. Press  or  to choose the dial line (account), and then press **Save**.

### To edit existing Speed Dial entries:

1. Select the entry in the Speed Dial list then press **Edit**.
2. Press  or  to select an item to edit.
3. Use the keypad to change the Name and Number.
  - Press **Del.** to delete characters.
4. Press  or  to change the Dial line (account).
5. When you are done editing, press **Save**. To cancel without saving, press .

### To delete existing Speed Dial entries:

1. Select the entry in the Speed Dial list, and then press **Del.**
2. Press **Yes** on the delete confirmation screen.



## Setting lift handset to answer

---

You can enable your handset to automatically answer a call when lifted from the charging cradle.

### To set Lift HS answer:

1. Press the **MENU/Confirm** key.
2. Press **▼** and **➤** to select  (Settings), then press **OK**.
3. Press **▲** or **▼** to scroll to **User settings**, and press **Enter**.
4. Press **▲** or **▼** to scroll to **Lift HS answer**, and press **Enter**.
5. Press **◀** or **➤** to select Disabled or Enabled..
6. Press **Set** to save, or press **Back** to cancel.

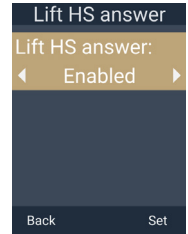

## Setting the missed call alert

---

You can enable or disable the missed call alert that is displayed on the handset screen.

### To set the missed call alert:

1. Press the **MENU/Confirm** key.
2. Press **▼** and **➤** to select  (Settings), then press **OK**.
3. Press **▲** or **▼** to scroll to **User settings**, and press **Enter**.
4. Press **▲** or **▼** to scroll to **Miss call alert**, and press **Enter**.
5. Press **▲** or **▼** to select On or Off.
6. Press **Set** to save, or press **Back** to cancel.

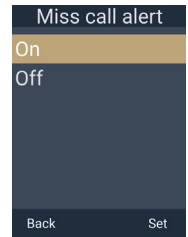

## Registering or deregistering your deskset

---

You can register or deregister your handset using the handset menu. Follow the instructions in "Handset Registration" on page 25.

# WebUI

## Using the WebUI

---

Use an Internet web browser to access the Web User Interface (WebUI) that resides on your base station. After you log on to the WebUI, you can configure the following features:

- Base Preferences
- User Preferences
- Base Directory
- Blocked List
- Remote XML directory
- User Password

The WebUI also has a System Status, Cordless Registrations, Cordless status and Base status page, where you can view network status and registration information about your handsets.

## How to identify the IP address of the base station

---

You need to know the IP address of the base station in order to access the WebUI. In a dual cell configuration, each base station has its own IP address. This section describes how to identify the IP address of an M500 base station.

1. On a handset/deskset registered to the base station, press the **MENU/Confirm** key.

The Main Menu appears.

**NOTE:** If you do not have any handsets/desksets registered to the base station, you can register a handset/deskset. Follow the instructions in “Manually registering via the LINK key on base station” on page 27.

2. Press **▼** and **▶** to select  (Settings), and then press **OK**.
3. With **Status** highlighted, press **Enter**.
4. With **Network** highlighted, press **Enter**.
5. Select the desired network protocol, **IPv4** or **IPv6** and then press **Enter**.  
The IPv4 or IPv6 screen appears:

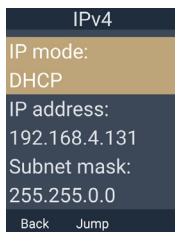

6. Press **▼** to highlight the **IP address**.
7. On your computer, open an Internet web browser.

8. Type the **IP address** from step 6 in the web browser address bar and press ENTER on your computer keyboard:



A Login window appears.

**NOTE:** If you have not yet changed the default user password, you will be prompted to change the user password before you can use the WebUI functions.

9. For the **Username**, enter **user**.
10. Enter the **Password**.
11. Click **Sign in**.
12. On the left sidebar of the web page, click **Status**, and then click **Base Status**.

The Base Status page appears.

13. If you see a **Mode** column, it indicates the base station's mode in a dual cell configuration. Look up the base station's **Mode** to find its corresponding IP address in the **IP** column. Use this IP address to access the WebUI. See "Accessing the WebUI" on page 76.

In the example below, the Primary base station's IP address is 10.91.20.11 and the Secondary base station's IP address is 10.91.20.109.

#### Base Status

Base	IP	MAC	Version	Mode	Air Sync	Connection Status	No. of Localized Handsets
1	10.91.20.11	00:04:13:BB:02:E0	1.14.2	Primary	-	Connected	3
2	10.91.20.109	00:04:13:BB:04:C7	1.14.2	Secondary 1	Synced	Connected	1

14. If you do not see a **Mode** column, it indicates a single cell configuration. The **IP** column shows the base station's IP address (which matches the IP address displayed on the handset/deskset). Use this IP address to access the WebUI. However, at this point you have already accessed the WebUI (in Step 8).

In the example below, the base station's IP address is 10.91.20.71.

#### Base Status

Base	IP	MAC	Version	Connection Status	No. of Localized Handsets
1	10.91.20.71	00:04:13:BB:00:99	1.14.2	Connected	0

## Accessing the WebUI

1. Ensure that your computer is connected to the same network as your base station.
2. On your computer, open an Internet web browser. Depending on your web browser, some of the pages presented here may look different and have different controls.
3. Type the base station's IP address in the web browser address bar and press **ENTER** on your computer keyboard:



**NOTE:** If you do not know what IP address to use, see "How to identify the IP address of the base station" on page 74.

A Login window appears.

**NOTE:** If you have not yet changed the default user password, you will be prompted to change the user password before you can use the WebUI functions.

4. For the **Username**, enter **user**.
5. Enter the **Password**.
6. Click **Sign in**.

The WebUI appears.

A screenshot of the SNOM M500 WebUI interface. The top left corner features the "SNOM M500" logo. A dark navigation bar on the left contains the following menu items: STATUS, System Status (highlighted in blue), Cordless Registrations, Cordless Status, Base Status, SYSTEM, CONTACTS, and SERVICING. The main content area is white and displays the "General" section with the following information:

Model:	M500
Serial Number:	CHNLB28122100154
MAC Address:	00:04:13:BB:02:E0
RFPI:	1038C42D00
Link Status:	Connected
Boot Version:	
Software Version:	1.14.2
Hardware Version:	
Hardware Revision:	01
EMC Version:	0
Network Time Settings:	us.pool.ntp.org

Below the General section is the "Account Status" section with the following information:

Account 1:	Registered
Account 2:	Registered

Click topics from the navigation bar on the left side of the page, and then click the desired setting on the left side of the WebUI to see the page for that setting. You view and change settings in two different types of fields: drop-down lists and entry fields into which you type information. For your security, the WebUI times out after 10 minutes, so if it is idle for that time, you must log on again.

The remaining procedures in this section assume that you have already logged on to the WebUI.

## System Status

The System Status page shows:

- **General** information about your phone, including model, MAC address, and firmware version.
- **Account Status** information about your SIP account registration.
- **IPv4** and **IPv6** network information regarding your phone's network address and network connection.

The System Status page has no settings that you can change. You may need some of the status information for troubleshooting purposes.

STATUS	
System Status	
Cordless Registrations	
Cordless Status	
Base Status	
SYSTEM	
CONTACTS	
SERVICING	
	<b>General</b>
	Model: M500
	Serial Number: CHNLB28122100154
	MAC Address: 00:04:13:BB:02:E0
	RFPID: 1038C42D00
	Link Status: Connected
	Boot Version:
	Software Version: 1.14.2
	Hardware Version:
	Hardware Revision: 01
	EMC Version: 0
	Network Time Settings: us.pool.ntp.org
	<b>Account Status</b>
	Account 1: Registered
	Account 2: Registered
	<b>IPv4</b>
	IP Mode: dhcp
	IP Address: 10.91.20.11
	Subnet Mask: 255.255.0.0
	Gateway: 10.91.0.1
	Primary DNS: 10.88.162.6
	Secondary DNS: 10.88.162.10
	VPN: Disabled
	<b>IPv6</b>
	IP Mode: disable
	IP Address: ::
	Prefix: 0
	Gateway:
	Primary DNS:
	Secondary DNS:

## Cordless Registrations

The Cordless Registrations page enables you to register and deregister handsets/desksets. It also displays a list of registration status, IPEI and firmware.

**Register Handset**

Handset ID  IPEI

**Manual registration**

**Auto Registration**

Auto Registration: Disabled

**Cordless Registrations**

	Handset ID	Name	Registration Status	IPEI	Firmware
<input type="button" value="Deregister"/>	1:	Handset 1	Registered	032F53FF74	1.14.2
<input type="button" value="Deregister"/>	2:	Deskset 2	Registered	032F53FBD7	1.14.2
<input type="button" value="Deregister"/>	3:	Handset 3	Registered	032F54711D	1.14.2
<input type="button" value="Deregister"/>	4:	Handset 4	Registered	032F53F90A	1.14.2
	5:	Handset	Not Registered		
	6:	Handset	Not Registered		
	7:	Handset 7	Not Registered		

## Cordless Status

The Cordless Status page shows the handset name, IPEI and firmware for your handsets. It also shows to which M500 base each handset is localized.

**Cordless Status**

Base:

Cordless ID	Name	IPEI	Firmware	Shared Directory	In Range	Signal	Battery	In Cradle	Localized at Base
1	Handset 1	032F53FF74	1.14.2	27	Yes	4	97	No	Primary
2	Deskset 2	032F53FBD7	1.14.2	27	Yes	4	100	Yes	Secondary 1
3	Handset 3	032F54711D	1.14.2	27	Yes	4	100	Yes	Secondary 1
4	Handset 4	032F53F90A	1.14.2	27	Yes	4	96	Yes	Primary

The Cordless Status page has no settings that you can change. You may need some of the status information for troubleshooting purposes.

## Base Status

The Base Status page shows information about each M500 base in your system.

snom  
M500

STATUS  
System Status  
Cordless Registrations  
Cordless Status  
**Base Status**  
SYSTEM  
CONTACTS  
SERVICING

Base Status

Base	IP	MAC	Version	Mode	Air Sync	Connection Status	No. of Localized Handsets
1	10.91.20.11	00:04:13:BB:02:E0	1.14.2	Primary	-	Connected	2
2	10.91.20.109	00:04:13:BB:04:C7	1.14.2	Secondary 1	Synced	Connected	2

## Base Preferences

The Base Preferences page enables configuration of the base mode. Do not make any changes on this page without first consulting with your system administrator.

snom  
M500

STATUS  
SYSTEM  
**Base Preferences**  
User Preferences  
Alarm  
CONTACTS  
SERVICING

General Base Settings

Mode:

Audio

Wideband Enabled

## User Preferences

On the User Preferences page, you can set the language that appears on the WebUI. After changing the setting on this page, click **Save** to save.

snom  
M500

STATUS  
SYSTEM  
Base Preferences  
**User Preferences**  
Alarm  
CONTACTS  
SERVICING

General User Settings

WebUI Language:

## Base Directory

To view the base directory, click **CONTACTS** in the WebUI sidebar, and then click **Base directory**.

On the Base directory page, you can manage your base directory entries. You can sort, edit, delete, and add contact information for up to 1,000 entries. The page also allows you to export your phone's base directory or import a base directory file. The export function lets you back up your contacts to your computer.

The Base directory lists entries across several pages. Click **Next**, **First**, **Last**, or a page number to view the desired page of entries.

**Note:** The Shared directory on your handset displays your base directory entries. For more information, see "Using the Directory" on page 56.



STATUS  
SYSTEM  
CONTACTS  
Base Directory  
Blocked List  
Remote XML  
SERVICING

### Local Directory

Select All  [Sort By Last Name](#)

Total: 20	First Name	Last Name	Ringer Tone	Work	Mobile	Other	Account	
<input type="checkbox"/>	Angela	Martin	0			7325550118	1	<a href="#">Edit</a>
<input type="checkbox"/>	Bronwyn	McDonald	0			2325550140	1	<a href="#">Edit</a>
<input type="checkbox"/>	Charlie	Johnson	0			5550198	1	<a href="#">Edit</a>
<input type="checkbox"/>	Dale	Appleton	0	6045550135			1	<a href="#">Edit</a>
<input type="checkbox"/>	David	Carter	3	2325550177		2325550194	2	<a href="#">Edit</a>
<input type="checkbox"/>	Davis	Swerdlow	0	2325550172			1	<a href="#">Edit</a>
<input type="checkbox"/>	Elkhart	Taxi	0	6045550155			1	<a href="#">Edit</a>
<input type="checkbox"/>	Graham	Ball	0	2325550176			1	<a href="#">Edit</a>
<input type="checkbox"/>	Kathryn	Dolphy	0	6045550195			1	<a href="#">Edit</a>
<input type="checkbox"/>	Linda	Miller	0	6045550117			2	<a href="#">Edit</a>
<input type="checkbox"/>	Lydia	Braithwaite	0			2325550157	1	<a href="#">Edit</a>
<input type="checkbox"/>	Martin	Meyers	0			2325550122	1	<a href="#">Edit</a>
<input type="checkbox"/>	Mary	Williams	0	6045550156	6045550146		1	<a href="#">Edit</a>
<input type="checkbox"/>	Richard	Serling	0	6045550141	7785550181		2	<a href="#">Edit</a>
<input type="checkbox"/>	Robert	Brown	2	6045550105			2	<a href="#">Edit</a>
<input type="checkbox"/>	Sandro	Voss	0			2325550149	1	<a href="#">Edit</a>
<input type="checkbox"/>	Stefan	Wheeler	0	2325550161			1	<a href="#">Edit</a>
<input type="checkbox"/>	Susan	Balance	0	6045550170			1	<a href="#">Edit</a>
<input type="checkbox"/>	Terry	Ng	0	2325550187			1	<a href="#">Edit</a>
<input type="checkbox"/>	Ursula	Baldwin	0			6045550166	1	<a href="#">Edit</a>

First [1](#) [2](#) [3](#) [Last](#) [Next](#)

[Delete Selected Entries](#) [Add New Entry](#)  
[Clear Directory](#)

### Import Local Directory

[Choose File](#)  
[Import XML](#)  
 First line is header, skip [Import CSV](#)

### Export Local Directory

[Export XML](#)  
[Export CSV](#)



Click	To...
<a href="#">Sort By Last Name</a>	Sort the list by last name.
<a href="#">Sort By First Name</a>	Sort the list by first name.
<a href="#">Edit</a>	Edit information for an entry.
<a href="#">First</a>	View the first page of entries.
<a href="#">Next</a>	View the next page of entries.
<a href="#">Last</a>	View the last page of entries.
<a href="#">Delete Selected Entries</a>	Delete selected entries from the directory. Click <b>Select All</b> to select every entry on the page you are viewing.
<a href="#">Clear Directory</a>	Delete all entries from the directory.
<a href="#">Add New Entry</a>	Add a new directory entry.
<a href="#">Clear Directory</a>	Delete all Directory entries.

### To add a new directory entry:

1. Click **Add New Entry**.

The **Create Local Directory Entry** page appears.

2. Enter the required information. At minimum, a first and last name are required.

Setting	Description	Range	Default
First Name	Enter the appropriate names in these fields.	N/A	N/A
Last Name			
Ringer Tone	Sets a unique ringer tone for calls from this directory entry.	Auto, Tone 1-10	Auto
Account	Sets the account used when you dial this directory entry.	Account 0-48 (0 = Default Account)	Account 1
Work Number	Enter the appropriate numbers in these fields.	N/A	N/A
Mobile Number			
Other Number			

3. Click **Save**.

## To edit a directory entry:

1. Click **Edit** for the entry you want to edit.

The **Edit Local Directory Entry** page appears.

**Edit Local Directory Entry**

First Name:

Last Name:

Ringer Tone:

Account:

Work Number:

Mobile Number:

Other Number:

2. Edit or add the desired information.
3. Click **Save**.

## Import Base directory

You can import an existing base directory file. Importing a directory file replaces all your previous base directory entries. After importing a directory file, you can add, edit, or delete entries as desired.

**Note:** Directory files are .xml or .csv files containing contacts and contact information. For more information about creating or editing a directory file, consult your system administrator.

## To import a base directory file:

1. Click **Choose File**.
2. In the popup window, navigate to the directory file.
3. Click the file, and then click **Open**.
4. If you are importing an XML file, click **Import XML**.
5. If you are importing a comma-separated value (CSV) file:
  - a. If the first line of the CSV file is a header line, click the **First line is header, skip** checkbox.
  - b. Click **Import CSV**.

## Export Base directory

You can export the directory and save it as an .xml file on your computer.

## To export the base directory:

1. Click **Export XML or Export CSV**.
2. If prompted by your browser, save the file to the desired location on your computer.

## Blocked List

To view the Blocked List, click **CONTACTS** in the WebUI sidebar, and then click **Blocked List**.

The Blocked List directory is identical to the Base directory, except that you cannot configure an incoming ringer tone.

The screenshot shows the SNOM M500 WebUI interface. The left sidebar contains navigation options: STATUS, SYSTEM, CONTACTS (with sub-items Base Directory, Blocked List, Remote XML), and SERVICING. The main content area is titled "Blocked List" and includes a "Select All" checkbox and a "Sort By Last Name" button. Below this is a table with columns: Total, First Name, Last Name, Work, Mobile, Other, Account, and an Edit button. The table contains one entry: I.M., Block, 7875552242, with an "Edit" button. Below the table are buttons for "Delete Selected Entries", "Clear Blocked List", and "Add New Entry".

Total	First Name	Last Name	Work	Mobile	Other	Account	
1	I.M.	Block	7875552242			1	Edit

## Remote XML

On the Remote XML page, you can configure up to three server-hosted Remote XML directories to appear on the Directory menu of your deskset.

The screenshot shows the SNOM M500 WebUI interface. The left sidebar contains navigation options: STATUS, SYSTEM, CONTACTS (with sub-items Base Directory, Blocked List, Remote XML), and SERVICING. The main content area is titled "Remote XML Directories" and features a table with columns: ID, Name, Remote XML URI, and Enable Incoming/Outgoing Call Lookup. There are three rows, each with input fields for Name and Remote XML URI, and a checkbox for Enable Incoming/Outgoing Call Lookup. A "Save" button is located at the bottom left of the table.

ID	Name	Remote XML URI	Enable Incoming/Outgoing Call Lookup
1	<input type="text"/>	<input type="text"/>	<input type="checkbox"/>
2	<input type="text"/>	<input type="text"/>	<input type="checkbox"/>
3	<input type="text"/>	<input type="text"/>	<input type="checkbox"/>

## Security

---

On the Security page, you can change the User Password that you use to access the WebUI.

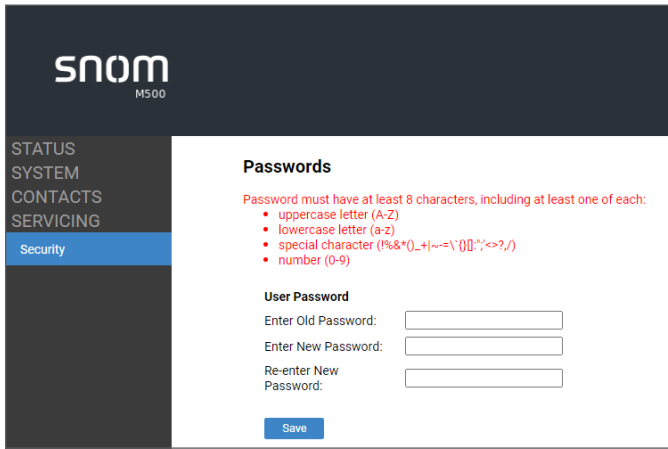

The screenshot shows the SNOM M500 web interface. On the left is a dark sidebar with a menu containing 'STATUS', 'SYSTEM', 'CONTACTS', 'SERVICING', and 'Security' (which is highlighted in blue). The main content area has a dark header with the 'snom M500' logo. Below the header, the page title is 'Passwords'. A red warning message states: 'Password must have at least 8 characters, including at least one of each:' followed by a bulleted list: 'uppercase letter (A-Z)', 'lowercase letter (a-z)', 'special character (!%&\*()\_+|-~=\| }[];':<>?,/)', and 'number (0-9)'. Under the heading 'User Password', there are three input fields: 'Enter Old Password:', 'Enter New Password:', and 'Re-enter New Password:'. A blue 'Save' button is located at the bottom of the form.

After entering your old password and new password, click **Save**.

# Troubleshooting

If you have difficulty with your handset, please try the suggestions below.

For customer service, visit our website at [www.snomamericas.com](http://www.snomamericas.com).

## General issues

---

### Handset does not work at all (LCD is black)

- Confirm the battery is installed and charged correctly.
- Place the handset into its charger. Ensure the charger is securely plugged into an outlet not controlled by a wall switch.
- If the battery is completely depleted, it can take up to 10 minutes to charge the battery before the low battery icon displays on screen.

### My caller ID isn't working.

- Caller ID is a subscription service. Your telephone service provider may require subscription to this service for this feature to work.
- The caller must be calling from an area that supports caller ID.
- Both your telephone service provider and your caller's service provider must use caller ID compatible equipment.

### Handset registration is not working

- Ensure the handset is within range of the base station.

### Cannot make external calls

- Check if your SIP account is registered. Press **MENU/Confirm** key →



(Settings) → **Status** → **Line** and select an account.

Check that the status is  (registered).

- You might be out of range of the base station. Try moving closer. If you see an idle screen with no alerts, then your handset is successfully communicating with the base station.

### Handset does not receive incoming calls

- Ensure that **Do Not Disturb** and **Call Forward All** are turned off.
- Check if your SIP account is registered. Press **MENU/Confirm** key →



(Settings) **Status** → **Line** and select an account.

Check that the status is  (registered).

- You might be out of range of the base station. Try moving closer.

### Poor audio quality. Speech is cutting out.

- You may be close to being out of range of the base station. Try moving closer.
- Other electronic products can cause interference with your handset.  
Try installing the base station far away from devices such as TVs, microwaves, or other cordless devices, including other handsets.
- If the problem persists, contact your system administrator.

## Technical Specifications

DECT frequency band	1921.536-1928.448 MHz
DECT output power	20.4dBm
Channels	5
Operating temperature	32-104 °F (0-40 °C)
Power requirements	Handset charger power adapter: Input: 100-240V AC 50/60Hz 0.3A, Output: 5VDC 2A (Model number: NBS10B050200VUU, Manufacturer: Mass Power)  Handset battery: 3.7V 1350mAh, Li-ion Polymer battery (Model number: 573554, Manufacturer: Shenzhen EPT Battery Co., Ltd.)
Bluetooth range	Up to 10m
Bluetooth frequency band	2402-2480MHz
Bluetooth output power	4.01dBm

# Special characters

## Entering special characters

When entering text using the keypad, press the **Abc / ABC / abc / 123** soft key or **✱** to switch between entry modes:

- **Abc** - Enter uppercase for the first letter of a word; lowercase for the other letters  
Press (space) to begin a new word.
- **ABC** - Enter uppercase letters
- **abc** - Enter lowercase letters
- **123** - Enter numerals

The following special characters are available when entering text.

Press a key repeatedly to cycle through the uppercase or lowercase characters.

Key	Uppercase	Lowercase	Numerals
1	~ ^ ` % ! & - _ + =	~ ^ ` % ! & - _ + =	1
2	A B C À Á Â Ã Ä Å Æ Ā Ą Ç Ć Ć	a b c à á â ã ä å æ ā ą ç ć Ć	2
3	D E F Đ È É Ê Ë Ě Ě	d e f đ è é ê ë ě ě	3
4	G H I Ğ Ĩ Í Î Ï	g h i ğ ĩ í î ï	4
5	J K L Ľ	j k l ľ	5
6	M N O Ñ Ń Ň Ò Ó Ô Õ Ö Æ	m n o ñ ń ñ ò ó ô õ ö æ	6
7	P Q R S Ŕ Š Š Š Š	p q r s ŕ š š š š	7
8	T U V Ť Û Ü Ú Û Ü	t u v ť ù ú û ü ü	8
9	W X Y Z Ý Ÿ Ž Ž Ž	w x y z ý ŷ ž ž ž	9
0	(space) ; , ? . @ ✱	(space) ; , ? . @ ✱	0
#	() [] {} < > / \ #	() [] {} < > / \ #	#

# Maintenance

## **Taking care of your telephone**

---

- Your base station and cordless handset contain sophisticated electronic parts, so you must treat them with care.
- Avoid rough treatment.
- Place the handset down gently.
- Save the original packing materials to protect your products if you ever need to ship them.

## **Avoid water**

---

- You can damage your cordless telephone if it gets wet. Do not use the handset in the rain, or handle it with wet hands. Do not install the base station and handset near a sink, bathtub or shower.

## **Electrical storms**

---

- Electrical storms can sometimes cause power surges harmful to electronic equipment. For your own safety, take caution when using electric appliances during storms.

## **Cleaning your telephone**

---

- Your products have a durable plastic casing that should retain its luster for many years. Clean it only with a soft cloth slightly dampened with water or a mild soap.
- Do not use excess water or cleaning solvents of any kind.

Remember that electrical appliances can cause serious injury if used when you are wet or standing in water. If the telephone base should fall into water, DO NOT RETRIEVE IT UNTIL YOU UNPLUG THE POWER CORD FROM THE WALL, then pull the unit out by the unplugged cord.



