

**snom**

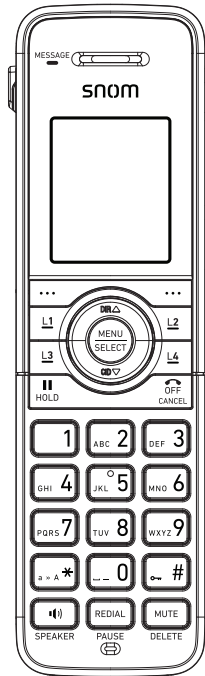

# M10 KLE

SIP DECT 4-Line Handset

User Manual



# User Manual

## M10 KLE

### SIP DECT 4-Line Handset

#### Table of Contents

<b>Copyright, Trademarks, GPL, Legal Disclaimers</b>	<b>4</b>	<b>Using the Handset</b>	<b>25</b>
<b>Important Safety Information</b>	<b>5</b>	Idle screen.....	25
Important safety instructions .....	5	Making calls.....	25
<b>For cUL compliance only</b>	<b>7</b>	Answering Incoming calls .....	26
<b>Mesures de sécurité importantes</b>	<b>7</b>	Multiple Incoming calls .....	26
Mesures de sécurité importantes.....	7	Ending a call.....	27
<b>Compliance</b>	<b>10</b>	Speakerphone.....	27
FCC part 15 .....	10	Volume.....	27
FCC Part 68 .....	10	Mute.....	27
Industry Canada.....	12	Call Waiting.....	28
<b>Introduction</b>	<b>13</b>	Ignoring calls.....	28
About this manual .....	13	Dismissing calls.....	28
Product overview.....	14	Missed Calls .....	28
<b>Quick Reference Guide</b>	<b>15</b>	Answering Internal calls.....	29
Cordless handset external features.....	15	Putting a call on hold .....	29
Dial pad and audio controls.....	15	Putting a call on private hold .....	30
<b>Factory Default Line Key Settings</b>	<b>16</b>	Switching between two calls.....	30
<b>Handset Installation</b>	<b>17</b>	Paging another handset/deskset .....	31
Installing the charger.....	17	Receiving a page.....	31
Battery installation and charging.....	18	About Shared Calls.....	32
Wall mounting the charger.....	20	Displaying calls on the Call List.....	35
Adding a corded headset.....	21	Barging In.....	36
Registering the handset to the base station.....	22	Call Privacy .....	36
Deregistering the handset.....	23	Using Key System Emulation .....	36
<b>Locating the Handset</b>	<b>24</b>	Transferring a call.....	39
<b>Screen icons</b>	<b>24</b>	Setting up a conference call .....	42
		Listening to messages .....	44
		Using the Directory .....	44
		Using the Call History .....	46

Using Speed Dial .....	48	Turning key tones on or off .....	57
<b>Configuring the Handset</b>	<b>49</b>	Registering or deregistering your handset .....	58
Setting do not disturb .....	49	<b>WebUI</b>	<b>59</b>
Setting call forwarding.....	49	Using the WebUI .....	59
Blocking anonymous calls .....	50	System Status .....	61
Dialing anonymously .....	50	Handset Status.....	62
Setting missed-call alerts.....	51	Call Settings.....	62
Setting call waiting.....	51	User Preferences .....	64
Viewing handset status.....	51	Base Directory .....	65
Setting the language .....	52	Blacklist.....	68
Setting the date and time .....	52	Remote XML .....	68
Setting the handset name .....	52	Security.....	68
Configuring the programmable keys.....	53	<b>Troubleshooting</b>	<b>69</b>
Programmable Key Types.....	54	General issues .....	69
Line key lights.....	55	<b>Technical Specifications</b>	<b>70</b>
Setting the screen contrast.....	56	<b>Special characters</b>	<b>70</b>
Backlight.....	56	Entering special characters.....	70
Setting the ringer tone and volume.....	57	<b>Maintenance</b>	<b>71</b>
Turning low battery tone on or off.....	57	Taking care of your telephone.....	71
Turning link lost tone on or off.....	57	<b>Appendix - GNU General Public License</b>	<b>72</b>

# Copyright, Trademarks, GPL, Legal Disclaimers

Copyright © 2019 Snom Technology GmbH

All Rights Reserved.

Snom, the names of Snom products, and Snom logos are trademarks owned by Snom Technology GmbH. All other product names and names of enterprises are the property of their respective owners.

Product specifications are subject to change without notice.

Snom Technology GmbH reserves the right to revise and change this document at any time, without being obliged to announce such revisions or changes beforehand or after the fact.

Texts, images, and illustrations and their arrangement in this document are subject to the protection of copyrights and other legal rights worldwide. Their use, reproduction, and transmittal to third parties without express written permission may result in legal proceedings in the criminal courts as well as civil courts.

When this document is made available on Snom's web page, Snom Technology GmbH gives its permission to download and print copies of its content for the intended purpose of using it as a manual. No parts of this document may be altered, modified or used for commercial purposes without the express written consent of Snom Technology GmbH.

Although due care has been taken in the compilation and presentation of the information in this document, the data upon which it is based may have changed in the meantime. Snom therefore disclaims all warranties and liability for the accurateness, completeness, and currentness of the information published, except in the case of intention or gross negligence on the part of Snom or where liability arises due to binding legal provisions.

Our firmware includes some source code that may be used and modified by anyone and everyone under the GNU Public License (GPL) (see "Appendix - GNU General Public License" on page 72), provided they, in turn, make it available to everyone else with the same licensing agreement. Please go to <https://www.snom.com/footer/source-code-gpl-open-source/> for the original GPL license and the source code of components licensed under GPL and used in Snom products.

# Important Safety Information



This symbol is to alert you to important operating or servicing instructions that may appear on the product or in this user's manual. Always follow basic safety precautions when using this product to reduce the risk of injury, fire, or electric shock.

## Important safety instructions

---

When using your telephone equipment, basic safety precautions should always be followed to reduce the risk of fire, electric shock and injury, including the following:

1. This product should be installed by a qualified technician.
2. This product should only be connected to the host equipment and never directly to the network such as Public Switch Telephone Network (PSTN) or Plain Old Telephone Services (POTS).
3. Read and understand all instructions.
4. Follow all warnings and instructions marked on the product.
5. Unplug this product from the wall outlet before cleaning. Do not use liquid or aerosol cleaners. Use a damp cloth for cleaning.
6. Do not use this product near water such as near a bath tub, wash bowl, kitchen sink, laundry tub or swimming pool, or in a wet basement or shower.
7. Do not place this product on an unstable table, shelf, stand or other unstable surfaces.
8. Slots and openings in the back or bottom of the base station and handset are provided for ventilation. To protect them from overheating, these openings must not be blocked by placing the product on a soft surface such as a bed, sofa or rug. This product should never be placed near or over a radiator or heat register. This product should not be placed in any area where proper ventilation is not provided.
9. This product should be operated only from the type of power source indicated on the marking label. If you are not sure of the type of power supplied at the premises, consult your dealer or local power company.
10. Do not allow anything to rest on the power cord. Do not install this product where the cord may be walked on.
11. Never push objects of any kind into this product through the slots in the base station or handset because they may touch dangerous voltage points or create a short circuit. Never spill liquid of any kind on the product.
12. To reduce the risk of electric shock, do not disassemble this product, but take it to an authorized service facility. Opening or removing parts of the base station or handset other than specified access doors may expose you to dangerous voltages or other risks. Incorrect reassembling can cause electric shock when the product is subsequently used.
13. Do not overload wall outlets and extension cords.

14. Unplug this product from the wall outlet and refer servicing to an authorized service facility under the following conditions:
  - A. When the power supply cord or plug is damaged or frayed.
  - B. If liquid has been spilled onto the product.
  - C. If the product has been exposed to rain or water.
  - D. If the product does not operate normally by following the operating instructions. Adjust only those controls that are covered by the operation instructions. Improper adjustment of other controls may result in damage and often requires extensive work by an authorized technician to restore the product to normal operation.
  - E. If the product has been dropped and the telephone base and/or handset has been damaged.
  - F. If the product exhibits a distinct change in performance.
15. Avoid using a telephone (other than cordless) during an electrical storm. There is a remote risk of electric shock from lightning.
16. Do not use the telephone to report a gas leak in the vicinity of the leak. Under certain circumstances, a spark may be created when the adapter is plugged into the power outlet, or when the handset is replaced in its cradle. This is a common event associated with the closing of any electrical circuit. The user should not plug the phone into a power outlet, and should not put a charged handset into the cradle, if the phone is located in an environment containing concentrations of flammable or flame-supporting gases, unless there is adequate ventilation. A spark in such an environment could create a fire or explosion. Such environments might include: medical use of oxygen without adequate ventilation; industrial gases (cleaning solvents; gasoline vapors; etc.); a leak of natural gas; etc.
17. Only put the handset of your telephone next to your ear when it is in normal talk mode.
18. The power adapters are intended to be correctly oriented in a vertical or floor mount position. The prongs are not designed to hold the plug in place if it is plugged into a ceiling, under-the-table or cabinet outlet.
19. Use only the power cord indicated in this manual.
20. For pluggable equipment, the socket-outlet shall be installed near the equipment and shall be easily accessible.
21. In wall mounting position, make sure to mount the telephone base on the wall by aligning the eyelets with the mounting studs of the wall plate. Then slide the telephone base down on both mounting studs until it locks into place. Refer to the full installation instructions in "Handset Installation" on page 17 in this User Manual.
22. CAUTION: Keep small metallic objects such as pins and staples away from the handset receiver.

**SAVE THESE INSTRUCTIONS**

## For cUL compliance only

### Mesures de sécurité importantes



Ce symbole vous alertera d'informations importantes ou d'instructions d'entretien pouvant apparaître dans ce guide d'utilisation. Respectez toujours les mesures de sécurité et de sécurité de base lorsque vous utilisez ce produit, afin de réduire les risques de blessures, d'incendie, ou d'électrocution.

#### Mesures de sécurité importantes

---

Afin de réduire les risques d'incendie, de blessures corporelles ou d'électrocution, suivez toujours ces mesures préventives de base lorsque vous utilisez votre téléphone

1. Cet appareil doit être installé par un technicien qualifié.
2. Cet appareil doit être branché à un équipement hôte et jamais branché à un réseau, tel qu'un réseau PSTN public ou un réseau téléphonique standard (POTS).
3. Lisez et comprenez bien toutes les instructions.
4. Observez toutes les instructions et mises en garde inscrites sur l'appareil.
5. Débranchez ce téléphone de la prise murale avant de le nettoyer. N'utilisez pas de nettoyeurs liquides ni en aérosol. N'utilisez qu'un chiffon doux et légèrement humecté.
6. N'utilisez pas ce produit près de l'eau, tel que près d'un bain, d'un lavabo, d'un évier de cuisine, d'un bac de lavage ou d'une piscine, ou dans un sous-sol humide ou sous la douche.
7. Ne déposez pas ce téléphone sur un chariot, support ou table chancelants. L'appareil pourrait tomber et être sérieusement endommagé.
8. Le boîtier de l'appareil est doté de fentes et d'ouvertures d'aération situées à l'arrière ou en dessous. Afin d'empêcher la surchauffe, ces ouvertures ne doivent pas être obstruées en plaçant l'appareil sur un lit, divan, tapis ou autre surface similaires. Ne placez pas cet appareil à proximité d'un élément de chauffage ni d'une plinthe électrique. De plus, ne l'installez pas dans une unité murale ou un cabinet fermé qui ne possède pas d'aération adéquate.
9. Ne faites fonctionner cet appareil qu'avec le type d'alimentation indiqué sur les étiquettes de l'appareil. Si vous ne connaissez pas le voltage de votre maison, consultez votre marchand ou votre fournisseur d'électricité.
10. Ne déposez rien sur le cordon d'alimentation. Installez cet appareil dans un endroit sécuritaire, là où personne ne pourra trébucher sur la ligne d'alimentation ni le cordon téléphonique modulaire.
11. N'insérez jamais d'objets à travers les fentes et ouvertures de cet appareil, car ils pourraient toucher à des points de tension dangereux ou court-circuiter des pièces, ce qui constituerait un risque d'incendie ou d'électrocution. N'échappez pas de liquides dans l'appareil.

12. Afin de réduire les risques d'électrocution, ne démontez pas l'appareil, mais apportez-le plutôt à un centre de service qualifié s'il doit être réparé. En enlevant le couvercle, vous vous exposez à des tensions dangereuses ou autres dangers similaires. Un remontage inadéquat peut être à l'origine d'une électrocution lors d'une utilisation ultérieure de l'appareil.
13. Ne surchargez pas les prises de courant ni les rallonges électriques, car ceci peut constituer un risque d'incendie ou d'électrocution.
14. Débranchez cet appareil de la prise de courant et communiquez avec le département de service à la clientèle de Snom dans les cas suivants:
  - A. Lorsque le cordon d'alimentation est endommagé ou écorché.
  - B. Si du liquide a été échappé dans l'appareil.
  - C. Si l'appareil a été exposé à une source d'humidité telle que la pluie ou l'eau.
  - D. Si l'appareil ne fonctionne pas normalement en suivant les directives du guide. N'ajustez que les commandes couvertes dans le guide d'utilisation, car un mauvais réglage de celles-ci peut être à l'origine de dommages, ce qui nécessiterait des réparations considérables pour remettre l'appareil à son état de fonctionnement normal.
  - E. Si l'appareil a été échappé ou son boîtier, endommagé.
  - F. Si le produit affiche une nette diminution de sa performance.
15. Évitez d'utiliser un téléphone (autre qu'un sans fil) pendant un orage. Les éclairs peuvent être à l'origine d'une électrocution.
16. N'utilisez pas le téléphone pour rapporter une fuite de gaz à proximité de celle-ci. Sous certaines circonstances, une intécille pourrait survenir lorsque l'adaptateur est branché à une prise de courant, ou lorsque le combiné est déposé sur le combiné. Ceci est un événement commun associé avec la fermeture d'un circuit électrique. L'utilisateur ne devrait pas brancher le téléphone dans une prise de courant, et ne devrait pas déposer le combiné chargé sur le socle, si le téléphone se trouve dans un environnement où la concentration de gaz inflammables, sans ventilation adéquate. Une étincelle dans ces endroits pourrait provoquer un incendie ou une explosion. Ces environnements pourraient être l'utilisation médicale de l'oxygène sans ventilation adéquate; le gaz industriel (dissolvants, vapeurs d'essence, etc.); une fuite de gaz naturel, etc.
17. Placez uniquement le combiné de votre appareil près de votre oreille lorsqu'il est en mode de conversation normal.
18. Les adaptateurs sont conçus pour être orientés en position verticale ou en position horizontale sur le plancher.
19. N'utilisez que cordon d'alimentation et les piles indiquées dans ce guide d'utilisation.
20. Pour les PRODUITS À BRANCHER À UNE PRISE DE COURANT, la prise de courant doit être installée près du produit, afin d'assurer une accessibilité sécuritaire à la prise de courant.



21. En position de montage mural, assurez-vous de monter le socle du téléphone sur le mur en alignant les oeilletons avec les goujons de fixation de la plaque murale. Ensuite, faites glisser le socle vers le bas sur les deux goujons de fixation jusqu'à ce qu'il se verrouille en place. Reportez-vous aux instructions complètes dans la section Installation dans ce guide d'utilisation.
22. MISE EN GARDE : Éloignez les petits objets métalliques tels que les broches de l'écouteur du combiné.

## **CONSERVEZ CES INSTRUCTIONS**

# Compliance

## FCC part 15

---

This device complies with Part 15 of the FCC rules. Operation is subject to the following two conditions: (1) This device may not cause harmful interference, and (2) this device must accept any interference received, including interference that may cause undesired operation.

This equipment has been tested and found to comply with the limits for a Class A digital device, pursuant to Part 15 of the FCC Rules. These limits are designed to provide reasonable protection against harmful interference when the equipment is operated in a commercial environment. This equipment generates, uses, and can radiate radio frequency energy and, if not installed and used in accordance with the instruction manual, may cause harmful interference to radio communications. Operation of this equipment in a residential area is likely to cause harmful interference in which case the user will be required to correct the interference at the user's expense.

Privacy of communications may not be ensured when using this phone.

Warning: Changes or modifications to this equipment not expressly approved by the party responsible for compliance could void the user's authority to operate the equipment.

Caution: To maintain the compliance with the FCC's RF exposure guideline, place the base unit at least 20 cm from nearby persons.

For body-worn operation, this handset has been tested and meets the FCC RF exposure guidelines when used with the accessories supplied or designated for this product. Use of other accessories may not ensure compliance with FCC RF exposure guidelines.

## FCC Part 68

---

Consumer Information:

- a. This equipment complies with Part 68 of the FCC rules and the requirements adopted by the ACTA. On the bottom of this equipment is a label that contains, among other information, a product identifier in the format **US:AAAEQ##TXXXX**. If requested, this number must be provided to the telephone company.
- b. An applicable certification jacks Universal Service Order Codes (USOC) for the equipment is provided (i.e., **RJ45C**) in the packaging with each piece of approved terminal equipment.
- c. A plug and jack used to connect this equipment to the premises wiring and telephone network must comply with the applicable FCC Part 68 rules and requirements adopted by the ACTA. A compliant LAN cable (RJ45) and modular plug is provided with this product. An RJ45 jack should normally be used for connecting to the SIP equipment through the LAN cable. See installation instructions for details.

## Compliance

- d. If this equipment causes harm to the telephone network, the telephone company will notify you in advance that temporary discontinuance of service may be required. But if advance notice isn't practical, the telephone company will notify the customer as soon as possible. Also, you will be advised of your right to file a complaint with the FCC if you believe it is necessary.
- e. The telephone company may make changes in its facilities, equipment, operations or procedures that could affect the operation of the equipment. If this happens the telephone company will provide advance notice in order for you to make necessary modifications to maintain uninterrupted service.
- f. Should you experience trouble with this equipment, please contact  
Snom Technology GmbH  
1 (339) 227-6160 (select option 2)  
for repair or warranty information. If the equipment is causing harm to the telephone network, the telephone company may request that you disconnect the equipment until the problem is resolved.
- g. Please follow instructions for repairing if any (e.g. battery replacement section); otherwise do not alternate or repair any parts of device except specified.
- h. Connection to party line service is subject to state tariffs. Contact the state public utility commission, public service commission or corporation commission for information.
- i. **NOTICE:** If your home has specially wired alarm equipment connected to the telephone line, ensure the installation of this M10 KLE does not disable your alarm equipment.  
If you have questions about what will disable alarm equipment, consult your telephone company or a qualified installer.
- j. This equipment is hearing aid compatible.

**NOTICE:** According to telephone company reports, AC electrical surges, typically resulting from lightning strikes, are very destructive to telephone equipment connected to AC power sources. To minimize damage from these types of surges, a surge arrester is recommended.

# Compliance

## Industry Canada

---

This Class A digital apparatus complies with Canadian requirements: CAN ICES-3 (A)/NMB-3(A). Cet appareil numérique de la classe A est conforme à la norme CAN ICES-3 (A)/NMB-3(A) du Canada.

This device contains licence-exempt transmitter(s)/receiver(s) that comply with Innovation, Science and Economic Development Canada's licence-exempt RSS(s).

Operation is subject to the following two conditions: (1) this device may not cause interference, and (2) this device must accept any interference, including interference that may cause undesired operation of the device.

Privacy of communications may not be ensured when using this telephone.

The term "IC:" before the certification/registration number only signifies that the Industry Canada technical specifications were met.

This product meets the applicable Innovation, Science, and Economic Development Canada technical specifications.

# Introduction

## About this manual

---

This user manual provides installation and handset configuration instructions, and detailed instructions for using the M10 KLE SIP DECT 4-Line Handset with firmware version 1.0.2.1.

See "Viewing handset status" on page 51 for instructions on how to check the software version of your M10 KLE SIP DECT 4-Line Handset and/or M100 KLE SIP DECT 4-Line Base Station.

Please read Important Safety Information on page 4 of this user manual.

Please thoroughly read this user manual for all the feature operations and troubleshooting information necessary to install and operate your handset.

Please refer to the *M100 KLE Administrator and Provisioning Manual* for complete configuration instructions.

For customer service or product information, visit our website at

**[www.snomamericas.com](http://www.snomamericas.com)**.

## Product overview

---

The M10 KLE SIP DECT 4-Line Handset, combined with the M100 KLE SIP DECT 4-Line Base Station, is a full-featured SIP endpoint business phone system designed to work with popular hosted IP PBX services and on-premise SIP PBXs. Once you have ordered and configured your PBX service, the handset enables you to make and receive calls as you would with any other business phone. Up to 10 cordless devices (M10 KLE handsets, M10R KLE handsets, and/or M18 KLE desksets) can be registered to the base station. Each handset provides calling features such as hold, transfer, conferencing, and speakerphone.

The M100 KLE SIP DECT 4-Line Base Station supports shared calls among multiple cordless handsets/desksets with a single SIP account. With Key System Emulation, the line keys (L1 to L4) on handsets/desksets can be configured as KeyLine type, which enables the keys to be used as for making calls, picking up held calls, and barging in calls.

The features of the M10 KLE SIP DECT 4-Line Handset include:

- Backlit Liquid Crystal Display
- Speakerphone, Hold and Mute
- Up to 8 SIP accounts
- Up to 6 concurrent calls across all handsets
- Shared call usage on single SIP account among multiple users
- Key System Emulation
- 4 line keys (L1-L4) with LEDs (can be reprogrammed as shortcuts to other features)
- Message waiting alert LED
- 3-way conferencing
- Corded headset support
- 500-entry local directory
- 1,000-entry base directory with entries shared on all registered handsets and desksets

# Quick Reference Guide

## Cordless handset external features

### HEADSET JACK

2.5 mm jack for connecting a corded headset.

### SOFT KEYS

Perform the actions indicated by the on-screen labels.

### L1 - L4

Line keys with LEDs for call handling. Can be reprogrammed as shortcuts to other features.

### CID ▼

While in menus, press ▼ to scroll down the menu. Press to display the Call history.

### HOLD

Press to put a call on hold.

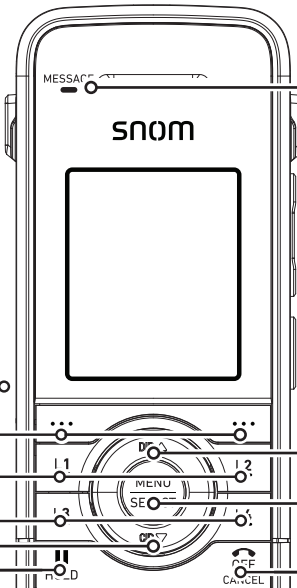

### MESSAGES light

Flashes when an account has a new voice message.

### - VOLUME +

During a call: increase or decrease listening volume. When idle: increase or decrease ringer volume.

### INT

Press to make an internal (intercom) call to another handset/deskset.

### DIR ▲

While in menus, press ▲ to scroll up the menu. Press to display Directory.

### MENU/SELECT

Press to display the main menu or context menu. Press to select a menu item.

### OFF/CANCEL

Press to end a call. Press to cancel an operation and leave a menu.

On back:

**BELT CLIP**

**SPEAKER**

## Dial pad and audio controls

### DIAL PAD

### SPEAKER

Press to use the handset speakerphone.

### REDIAL/PAUSE

Press to redial a number or enter a pause when programming a phone number.

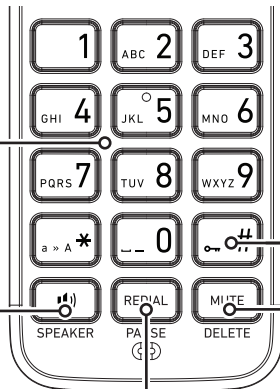

### HANDSET LOCK

Press and hold to lock handset keys and prevent accidental key presses.

### MUTE/DELETE

During a call, press to prevent your voice from being heard. While entering numbers or letters, press to delete previous character.

## Factory Default Line Key Settings

Your base station and handsets have a factory default configuration where the line keys (L1 to L4) are set up to handle a shared line.

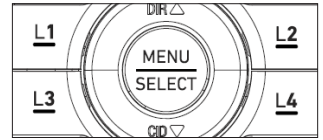

- All handset users can use the shared line via the line keys (L1 to L4).
- The LEDs on the line keys (L1 to L4) will be on or flashing to indicate calls in progress across all handsets.
- A handset user can make a new call, pick up a held shared call, or barge in a shared call by pressing the line keys (L1 to L4).

For more information, see "Using Key System Emulation" on page 36.



# Handset Installation

This section assumes that your network infrastructure is established and that your IP PBX phone service has been ordered and configured for your location.

Handset installation involves both the handset and the handset charger. The charger is powered using the supplied power adapter. The charger can be placed on a flat surface or mounted on a wall.

Avoid placing the handset and charger too close to:

- Communication devices such as television sets, DVD players, or other cordless telephones
- Excessive heat sources
- Noise sources such as a window with traffic outside, motors, microwave ovens, refrigerators, or fluorescent lighting
- Excessive dust sources such as a workshop or garage
- Excessive moisture
- Extremely low temperature
- Mechanical vibration or shock such as on top of a washing machine or work bench

## Installing the charger

---

Install the charger as shown below.



Plug the power adapter into an electrical outlet not controlled by a wall switch.

## IMPORTANT INFORMATION



1. Use only the power adapter supplied with this product.  
To order a replacement power adapter, visit our website at [www.snomamericas.com](http://www.snomamericas.com).
2. The power adapter is intended to be correctly oriented in a vertical or floor mount position. The prongs are not designed to hold the plug in place if it is plugged into a ceiling, under-the-table or cabinet outlet.

### Battery installation and charging

---

Install the battery as shown on the following page. Once you have installed the battery, the screen indicates the battery status (see the table below). If necessary, place the handset in the charger to charge the battery. For best performance, keep the handset in the charger when not in use. The battery is fully charged after 11 hours of continuous charging.

If the screen is blank, you need to charge the handset without interruption for at least 30 minutes to give the handset enough charge to use the telephone for a short time. When the battery is low, the handset shows **Low battery** and a flashing .

Battery indicators	Battery Status	Action
The screen is blank or shows <b>Place in charger</b> and  flashes.	The battery has no or little charge. The handset cannot be used.	Charge without interruption (at least 30 minutes).
The screen shows <b>Low battery</b> and  flashes.	Battery has enough charge to be used for a short time.	Charge without interruption (at least 30 minutes).
Full battery icon (  ) appears.	Battery is charged.	To keep the battery charged, place it in the charger when not in use.

### To install the handset battery:

1. Plug the battery connector securely into the socket inside the handset battery compartment. Insert the supplied battery with the label THIS SIDE UP facing up as indicated.
2. Align the cover flat against the battery compartment, then slide it upwards until it clicks into place.



3. Charge the handset by placing it face forward in the charger. The battery icon indicates the charge status as the battery charges.

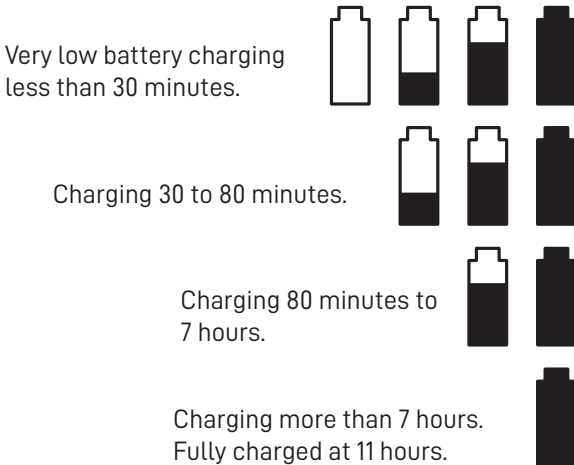

### IMPORTANT INFORMATION

- Use only the supplied rechargeable battery or replacement battery (model BT264392). To order a replacement battery, visit our website at **www.snomamericas.com**.
- If you do not use the handset for a long time, disconnect and remove the battery to prevent possible leakage.

## Wall mounting the charger

---

The charger is ready for tabletop use. If you want to mount the charger on a wall, use two 10 mm (7/16 inch) screws and wall anchors (not provided) to hold the charger in place. Screws and wall anchors are not provided, but are available for purchase at hardware retailers. You might need a professional to install the charger.

### To mount the charger on the wall:

1. Use a pencil to mark the desired positions of the two holes on the wall. Make sure the space between the two holes is 30 mm. Drill two holes in the wall according to the marks.

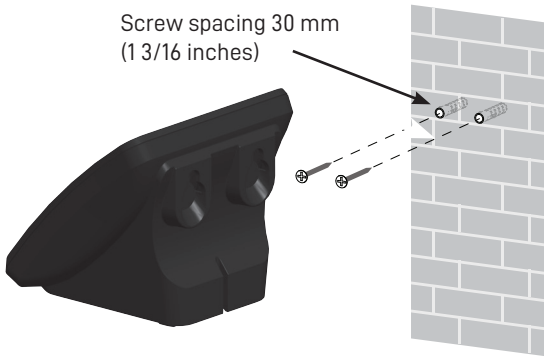

2. If you drill the holes into a stud, go to step 3.  
-OR-

If you drill the holes into an object other than a stud, insert the wall anchors (not provided) into the holes and tap gently on the ends with a hammer until the wall anchors are flush with the wall.

3. Insert the screws (not provided) into the holes and tighten them until only 1/4 inch of the screws are exposed.
4. Align the holes at the back of the charger with the screws on the wall and slide the charger down until it locks into place.



## Adding a corded headset

---

You can use this handset hands-free when you install any industry-standard 2.5 mm corded telephone headset (purchased separately).

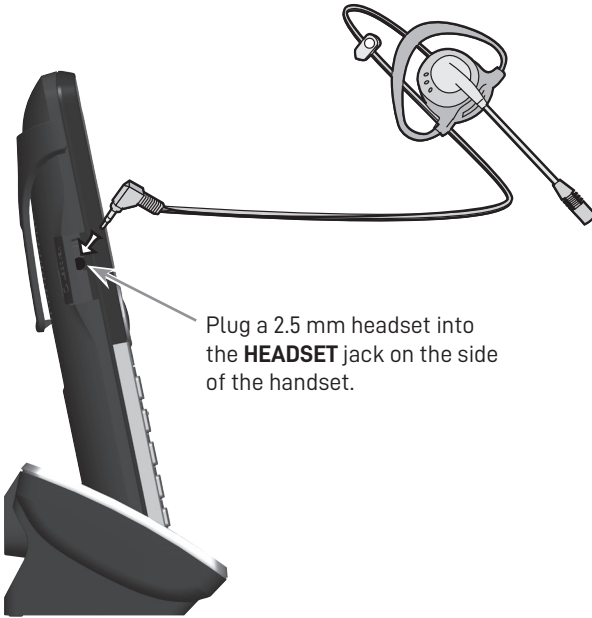

## Registering the handset to the base station

---

The handset must be registered to the base station in order to make and receive calls.

### To register the handset:

1. Make sure the handset has a charged battery before proceeding.  
Make sure the base station is connected to power.

2. If the handset is displaying  go to step 6.

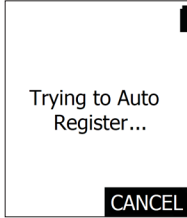

3. If the handset is displaying  go to step 7.

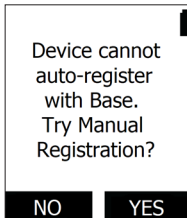

4. If the handset is displaying   go to step 8.

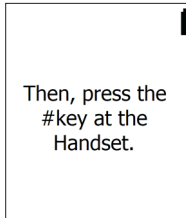
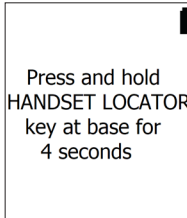

5. If the handset is displaying  go to step 7.

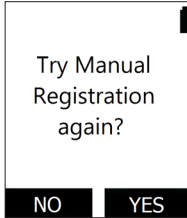

6. Press **CANCEL**.

The handset displays the following message:

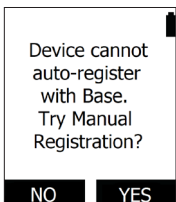

7. Press **YES**.

The handset displays the following message:

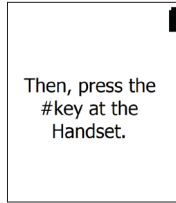
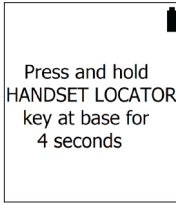

8. On the base station, press the **HANDSET LOCATOR** button for at least four seconds, then release the button. Both LEDs on the base station begin to flash.
9. Press the **#** key on the handset to begin registration. The screen displays "Registering Please wait".  
The process takes up to 10 seconds to complete. When registration is complete, the handset beeps and displays "Handset Registered".  
If the handset fails to register, place it in the charger again for a few seconds, remove it and repeat the registration procedure.

## Deregistering the handset

---

Before using the handset with a different base station, you must deregister the handset from the base station to which it is currently registered.

### To deregister the handset:

1. Press **MENU** on the handset. The Main Menu appears.
2. Press **▼** to scroll to **User settings** and press **SELECT**.
3. Press **▼** to scroll to **Registration** and press **SELECT**.
4. Press **▼** to highlight **Deregistration** and press **SELECT**.  
The handset screen displays a list of devices registered to the base station.
5. Press **▼** to highlight the name of the handset you want to deregister, and then press **SELECT**.
6. Enter the PIN, and then press **SELECT** to begin deregistration.  
The default PIN is 1592.  
The deregistration process takes up to 10 seconds to complete.  
When the handset deregisters, it beeps and the screen displays "Handset is deregistered."

**Note:** The handset enters an energy-saving charging mode after being deregistered. All cordless telephone functions except handset-battery charging are disabled. Energy-saving charging mode is deactivated after the handset registers to the base station.

## Locating the Handset



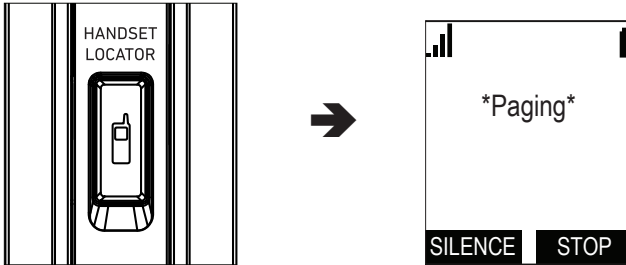



You can find handsets by paging them from the base station. Press the **HANDSET LOCATOR** (page) button on the base station to ring all handsets:



- All handsets within range of the base will ring for one minute, even if the volume is off.
- To end the locator page, press **END** .
- To silence the locator page on one handset only, press **MUTE**.

## Screen icons

The following screen icons indicate your phone's current status:

Icon	Status
	Indicates signal strength, from one bar (weak) to four bars (strong). Flashes when out of range.
	Indicates battery strength from 1/3 to 3/3. Flashes when empty.
	Indicates the currently displayed call is on hold with your handset. This icon is visible when displaying the Call List.
	The ringer is off.
	Headset—audio is coming through a headset after the <b>HEADSET</b> key was pressed.
	Speakerphone—the speakerphone is active.
	Microphone is muted.



# Using the Handset

This section describes how to use the handset to make calls and answer calls. This section also describes how to put calls on hold, transfer calls, and create conference calls.

## Idle screen

The Idle screen appears after the phone is connected and configured for your SIP PBX service. The Idle screen indicates that you have no active or held calls.

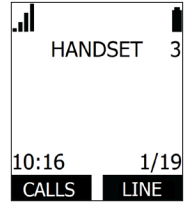

From the Idle screen, you can press:

- **CALLS** to view the Call List.  
See "Displaying calls on the Call List" on page 35.
- **LINE** to select another account (SIP Account).  
When you make a call, the phone will use this account.  
See "Making calls" below.
- **MENU** to view the main menu.  
See "Configuring the Handset" on page 49.

## Making calls

You can make calls to any phone number (an outside call), or you can call another handset (an internal call).

### To make an outside call:

1. Use the dial pad to enter the desired number.
  - Press **BACKSP** if you enter an incorrect digit.
2. Call the number by pressing an idle line key (**L1** to **L4**), **DIAL** or **SPEAKER** .

When the call is answered, the active call screen appears.

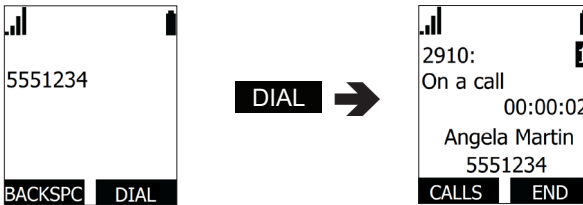

3. To end the call, press **OFF** or **END**, or place the handset in the charger.

### If you wish to choose an outgoing account for the outside call:

1. Press **LINE**.
2. Press **▼** or **▲** to select the dialing line (account).
3. Press **SELECT**.
4. Use the keypad to enter the desired number.  
The call will dial automatically when you have finished entering the number.

Note that you can also live dial a number by pressing an idle line key (**L1** to **L4**) or

**SPEAKER**  to go off hook before entering a phone number. The call will dial automatically when you have finished entering the phone number.

### To make an internal call to another handset or deskset:

1. Press the **INT** button on the right side of the phone  
-OR-  
Press **MENU**, press **▼** to scroll to **Intercom**, then press **ENTER**.
2. Press **▼** or **▲** to select the handset you wish to call, then press **SELECT**.  
If you select **All**, then you will be connected to the first handset to answer.  
When the call is answered, the active call screen appears.

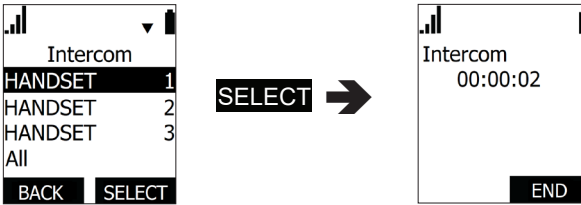

3. To end the call, press **OFF** or **END**, or place the handset in the charger.

### Answering Incoming calls

You can answer a call by pressing the flashing line key (**L1** to **L4**), **ANSWER** or

**SPEAKER**  :

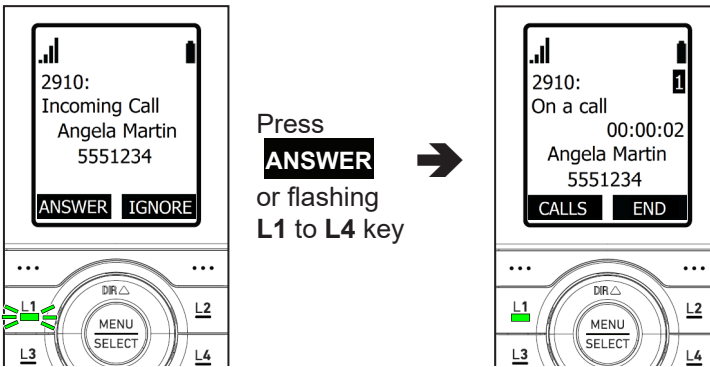

### Multiple Incoming calls

If you have multiple incoming calls, (as indicated by ):

- Press the flashing line key (**L1** to **L4**) for the call you want to answer  
-OR-  
• Press **▼** or **▲** to select the call you want to answer and press **ANSWER**.

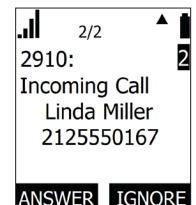

## Ending a call

---

### To end a call:

- Press **OFF** or **END**, or place the handset in the charger.

## Speakerphone

---

### To turn the speakerphone on/off during a call:

- Press **SPEAKER**  to switch between speakerphone and normal handset use.

When the speakerphone is active, the handset displays the speakerphone icon

 at the top of the screen.

## Volume

---

### To adjust the listening volume during a call:

- Press **VOLUME +** or **-** on the side of the handset.

## Mute

---

The mute function enables you to hear the other party, but the other party cannot hear you.

### To mute/unmute your handset's microphone during a call:

- Press **MUTE**.

When your handset's microphone is muted, the handset displays the mute

 icon at the top of the screen.

## Call Waiting

---

If you are on a call, and receive an incoming call from an outside number, the handset displays the Call Waiting screen. If you answer the call, your active call will be put on hold.

### To answer the incoming call:

- Press **ANSWER**.

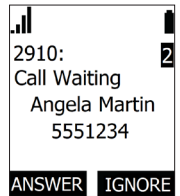

You can also ignore or reject the incoming call. See the next sections, "Ignoring calls" and "Rejecting calls."

## Ignoring calls

---

You can ignore an incoming call from an outside number if you don't want to answer the call right away, but want to pick up the call later.

- If you ignore the call during an active call, and no other handsets/desksets answer the ignored call, your handset will ring again for the ignored call when you disconnect your call.
- If you ignore the call while your handset is idle, your handset will not ring again for the ignored call.

### To ignore an incoming call:

- Press **IGNORE** on the "Incoming Call" screen or "Call Waiting" screen.

The ignored call will be shown in the Call List until it is picked up by another handset/deskset. You can pick up the ignored call from the Call List - see "To view the Call List:" on page 35.

## Dismissing calls

---

You can dismiss an incoming call from an outside number if you don't want to answer the call, and you don't want to pick up the call later.

- If you dismiss the call during an active call, the dismissed call will continue to ring on other handset/desksets until it is answered or ignored/dismissed by all handsets/desksets.
- Your handset will not ring again for the dismissed call.

### To dismiss an incoming call during an active call:

1. Press **MENU** on the "Call Waiting" screen.
2. Press **YES** at the prompt, "Dismiss call? Dismissed call does not ringback."

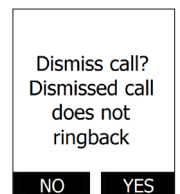

## Missed Calls

---

If you don't respond to an incoming outside call, the handset displays a missed-call alert on the idle screen.

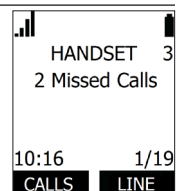

## Answering Internal calls

---

You can receive internal calls from another handset/deskset.

### To answer an internal call:

- Press **ANSWER**.



Internal calls from another handset/deskset cannot be rejected, but they can be silenced by pressing **MUTE**.

## Putting a call on hold

---

You can put an outside call on hold by pressing **HOLD**. The handset also puts calls on hold automatically when you answer another call, transfer a call, or create a conference. Note that you cannot put an internal call on hold.



### To take the call off hold:

1. Press **CALLS**.
2. If you have multiple calls on hold, (as indicated by ) , press ▼ or ▲ to select the call you want to take off hold.
3. Press **RESUME**.

If another party puts you on hold, you may see the message **Held by far end**. This message depends on compatibility between phones and PBX types, and may not always appear. You can press **END** to end the call.

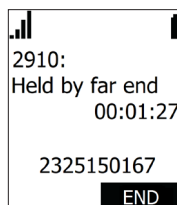

## To make a new call while on hold:

1. When you have a call on hold, use the dial pad to enter the number you wish to dial.
2. Call the number by pressing an idle line key (**L1** to **L4**), **DIAL** or **SPEAKER** 

## Putting a call on private hold

You can put a shared call on "private hold" to prevent other handsets/desksets from retrieving your held call from the Call List.

To put a shared call on "private hold," press and hold the **HOLD** button.

To resume the call, select it from the Call List.

## Switching between two calls

If you are managing two calls, you can switch between them by one of the following ways:

- Press the flashing line key (**L1** to **L4**) of the call you want to pick up

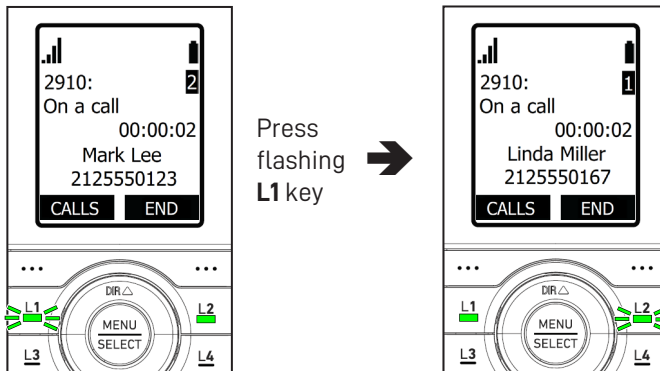

-OR-

- Press **CALLS**, and then press **RESUME**:



## Paging another handset/deskset

---

You can page another handset/deskset, and send one-way audio. The receiving handset/deskset will play an alert tone, and your voice on its speaker. If a corded headset is plugged in to the receiving handset/deskset, then audio is played on the headset.

You cannot hear the person. If you want to have a two-way conversation, make an internal call instead. For more information, see "To make an internal call to another handset or deskset:" on page 26.

In order for the page to work, both your handset and the receiving handset/deskset must be idle.

### To page a handset/deskset:

1. Press **MENU**.
2. Press ▼ to scroll to **Paging** and press **SELECT**.
3. Press ▼ or ▲ to select a handset/deskset, and press **SELECT**.

Your handset displays "Paging <device name>".

When a connection is established, your handset displays "Broadcasting" with a timer.

4. Speak into your handset.
5. To end the page, press **END** or **OFF**.

The receiving handset/deskset can also end the page.

The receiving handset/deskset will not receive the page if:

- It is on an active call
- It has an incoming call ringing
- It is off-hook (deskset)

When this occurs, your handset displays "Broadcasting" for five seconds, and then displays "Ended."

### Receiving a page

---

If you are paged by another handset/deskset, your handset will play an alert tone and display the message "Paged by: <device name>."

When the connection is established, your handset displays "Broadcasting" with a timer, and you will hear the person paging you. The other person cannot hear you.

### To end the page:

- Press **END** or **OFF**.

The other person can also end the page.

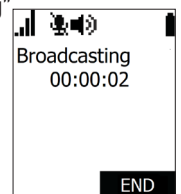
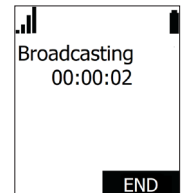
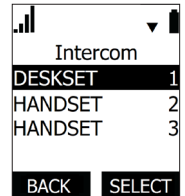

## About Shared Calls

---

A shared call is a call that can be picked up by any handset/deskset on a shared line.

Active and held shared calls are shown in the Call List, which can be displayed by pressing **CALLS** on your handset.

Private calls are only visible to the handset/deskset user who makes or answers the call.

Your system administrator will determine whether or not calls on a SIP account will be shared among handset/deskset users.

Whether or not calls on a SIP account will be shared among other handset/deskset users is configured by your system administrator via KeyLine assignment.

The following examples show how to use the Call List to pick up a held shared call and barge in an active shared call. Each example shows what the screen looks like on two different handsets.



**Example - picking up a held shared call:**

	Alice's handset	Bob's handset
1. Alice is on a call.		
2. Alice presses <b>HOLD</b> to put the call on hold.		
3. Alice shouts across the room, "Bob, can you pick up line 2?"		
4. Bob presses <b>CALLS</b> to display the Call List, and presses ▼ to select the call on line 2.		
5. Bob presses <b>RESUME</b> to pick up the call.		
The call is now on Bob's handset.		

**Example - barging in a shared call:**

	Alice's handset	Bob's handset
1. Alice is on a call.		
2. Alice shouts across the room, "Bob, can you join my call on line 3?"		
3. Bob presses <b>CALLS</b> to display the Call List, and presses ▼ to select the call on line 3.		
4. Bob presses <b>BARGE</b> to barge in the call.		
Bob is now in a conference call with Alice and the caller on line 3.		

## Displaying calls on the Call List

The Call List enables you to manage your own calls and shared calls within the system. The Call List displays:

- Shared calls on other handsets/desksets, which can be active, held, or barged-in calls.
- Calls held by your handset whether shared or private (indicated by ).
- Calls you ignored calls, which not are yet answered by other handsets/ desksets.



In the Call List, a number on the handset display indicates which KeyLine number is assigned to the call. KeyLine numbers 1-4 usually correspond to the **L1-L4** keys on the handset.

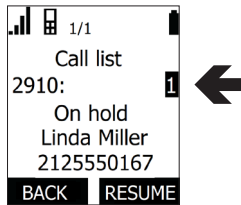

### To view the Call List:

1. Press **CALLS** .
2. If there are multiple calls in the Call List, (as indicated by  ), press ▼ or ▲ to select a call.
3. To retrieve a call on hold, press **RESUME** .
4. To "barge in" on a shared call, press **BARGE** .
5. To answer a call you previously ignored, press **ANSWER** .
6. To exit the Call List, press **BACK** .

## Barging In

---

You can "bargue in" on a shared call in progress on another handset/deskset that shares the account. Barging in establishes a three-way call with two internal parties. Only one barge in party is allowed per active call.

### To barge in on a call:

- Press the steady green line key (**L1** to **L4**) of the call you want to barge in.
- OR-
1. Press **CALLS** to display the Call List.
  2. Press **▼** or **▲** to select the call you want to barge in.
  3. Press **BARGE**.

## Call Privacy

---

During an active shared call, you can turn on Call privacy in order to prevent other handsets/desksets from barging in. The handset/deskset attempting to barge in displays the message "Call is not available at this time."

If Call privacy is on and your put your call on hold, then your handset resets Call privacy to "off". Other handsets/desksets can then pick up your call from the Call list, or barge in when you resume the call.

### To turn call privacy on/off during an active shared call:

1. Press **MENU**.
2. Press **▼** to scroll to **Call privacy** and press **SELECT**.
3. Press to **▼** or **▲** to select **On** or **Off**, then press **ENTER**.

When Call privacy is on, your handset's call screen shows "Private."

When Call privacy is off, your handset's call screen shows "On a call."

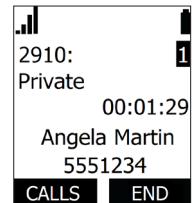

## Using Key System Emulation

---



Your phone is equipped with Key System Emulation, where four line keys (**L1** to **L4**) enable direct interaction with shared calls. The line keys (**L1** to **L4**) act like shortcuts to the calls in the Call List.

Key System Emulation can be useful for small businesses where incoming calls are answered by a group of people. Handset users can use the line keys to make new calls, answer incoming calls, pick up calls held by other users, or barge in other users' calls.

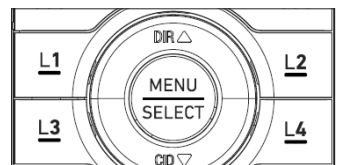
The following examples show how to use the line keys (**L1** to **L4**) to pick up a held shared call and barge in an active shared call. Each example shows what the screen and line key LEDs look like on two different handsets.

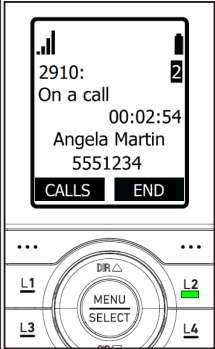
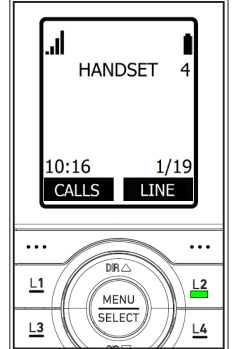
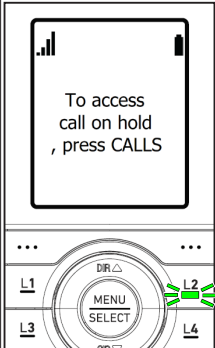
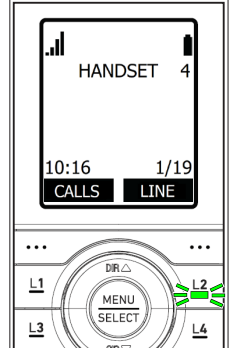
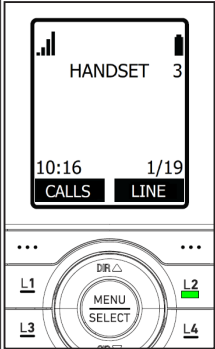

Example - picking up a held shared call:

	Alice's handset	Bob's handset
1. Alice is on a call.		
2. Alice presses <b>HOLD</b> to put the call on hold.		
3. Alice shouts across the room, "Bob, can you pick up line 2?"		
4. Bob presses <b>L2</b> to pick up the call.		
The call is now on Bob's handset.		

**Example - barging in a shared call:**

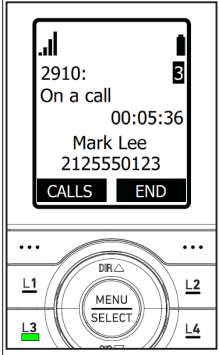
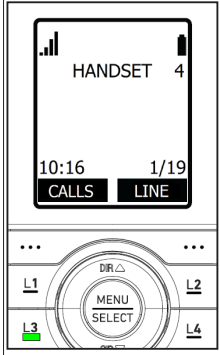
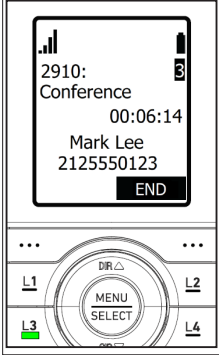
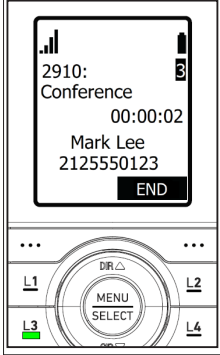
	Alice's handset	Bob's handset
1. Alice is on a call.		
2. Alice shouts across the room, "Bob, can you join my call on line 3?"		
3. Bob presses <b>L3</b> to barge in the call.		
Bob is now in a conference call with Alice and the caller on line 3.		

LEDs on the line keys (**L1-L4**) indicate the status of calls:

LED light	Indicates:	Press key to:
Off	Line is idle	Make a call
Fast flashing green	Ringing incoming call	Answer the call
Slow flashing green	Call is on hold on your handset OR another handset/deskset	Retrieve the held call
Steady green	Call is active on your handset; OR shared call is active on your handset or another handset/deskset	"Barge in" on the shared call

Your phone system has its factory default with SIP Account 1 and its four line keys (**L1-L4**) configured to provide a Key System experience. Ask your system administrator for other modes of operation.

## Transferring a call

You can transfer a call to another party.

If you talk to the transfer recipient before completing the transfer, you are making a "supervised" transfer.

However, the transfer recipient does not have to talk to you before receiving the transferred call. If you do not talk to the transfer recipient before transferring the call, you are making a "blind" transfer.

You can also transfer a call to a held call. Note that you cannot transfer internal calls.

### To transfer a call (supervised):

1. During a call, press **SELECT**.
2. Press ▼ to scroll to **Transfer** and press **SELECT**.



**SELECT** →

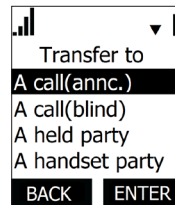

3. With **A call(annc.)** highlighted, press **SELECT**.  
The call is automatically put on hold.
4. Dial the number to which you want to transfer the call. Wait for the phone to automatically dial, once it recognizes a valid number.

OR

Press ▼ (Call History) or ▲ (Directory) and call a number from a list.

- When the second caller answers, you can talk to the caller to notify them of the transfer, then press **TRANS.** to transfer the call.

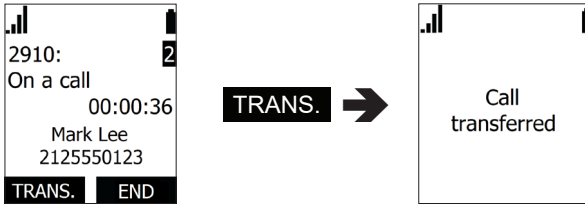

### To transfer a call (blind):

- During a call, press **SELECT**.
- Press ▼ to scroll to **Transfer** and press **SELECT**.



- Press ▼ to scroll to **A call(blind)**, then press **SELECT**.
- Dial the number to which you want to transfer the call.

OR

Press ▼ (Call History) or ▲ (Directory) and call a number from a list.

- Press **TRANS.** to transfer the call.

When the far end picks up, the call will be immediately transferred.

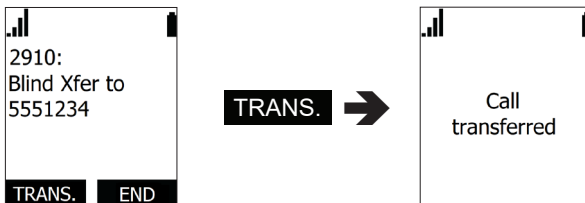



### To transfer a call to a held call:

1. During a call, press **SELECT**.
2. Press ▼ to scroll to **Transfer** and press **SELECT**.



**SELECT** →

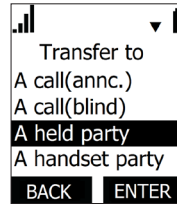

3. Press ▼ to scroll to **A held party**, then press **SELECT**.
4. Press ▼ or ▲ to select a held call to which you want to transfer, then press **SELECT**.
5. When the second call is established, you can talk to the caller to notify them of the transfer.
6. Press **TRANS.** to transfer the call.

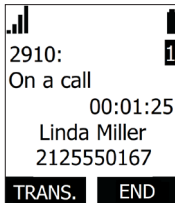

**TRANS.** →

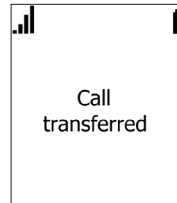

### To transfer a call to another handset / deskset in your system:

1. During a call, press **SELECT**.
2. Press ▼ to scroll to **Transfer** and press **SELECT**.



**SELECT** →

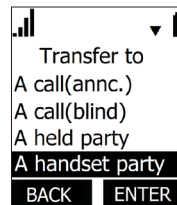

3. Press ▼ to scroll to **A handset party**, then press **SELECT**.
4. Press ▼ or ▲ to select a handset or deskset, then press **SELECT**.
5. When the second call is established, you can talk to the caller to notify them of the transfer.
6. Press **SELECT**.
7. With **Transfer** highlighted, press **SELECT** to transfer the call.

## Setting up a conference call

You can hold a conference call between yourself and two other parties.

### To set up a conference call with an outside number:

1. During a call, press **SELECT**.
2. Press ▼ to scroll to **Conference** and press **SELECT**.



3. With **A new party** highlighted, press **SELECT**.  
The call is automatically put on hold.
4. Dial the second number for the other party you want to join your conference. Wait for the phone to automatically dial, once it recognizes a valid number.

OR

Press ▼ (Call History) or ▲ (Directory) and call a number from a list.

5. When the second call is established, press **CONF**.  
The conference begins and the conference screen appears.

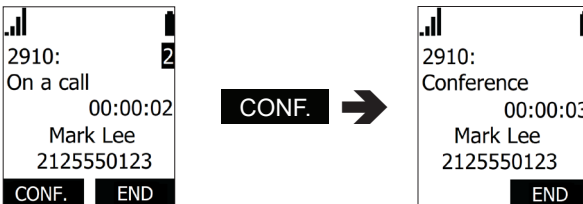

Press **END** to terminate both calls and end the conference.

### To create a conference with a held call:

1. If you are on an Active call and also have a call on hold, press **SELECT**.
2. Press ▼ to scroll to **Conference** and press **SELECT**.



3. Press ▼ to scroll to **A held party**, and then press **SELECT**.  
A list of held calls will appear.
4. Press ▼ or ▲ to select a held call you want to conference with, then press **SELECT**.
5. Press **CONF**.  
The conference will begin immediately.

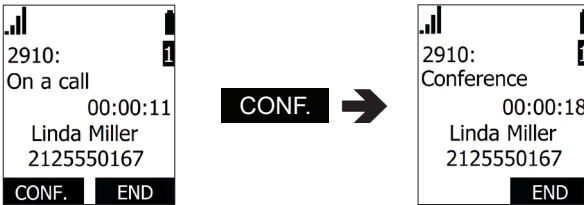

Press **CANCEL** to terminate both calls and end the conference.

### To set up a conference call with another handset / deskset in your system:

1. During a call, press **SELECT**.
2. Press ▼ to scroll to **Conference** and press **SELECT**.



3. Press ▼ to scroll to **A handset party**, then press **SELECT**.
4. Press ▼ or ▲ to select a handset or deskset, then press **SELECT**.
5. When the second call is established, press **SELECT** and press ▼ to scroll to **Conference**, then press **SELECT**.

The conference begins and the conference screen appears.

Press **END** to exit the conference. The two other callers remain connected to each other.

## Setting up a Network Conference:

A Network Conference is hosted by your service provider and allows multiple parties to join a conference. A Network Conference works in a similar way to the regular conference described above, except you can add as many parties as your service provider supports. Pressing **MENU** and selecting **Conference** during a conference will allow you to add more parties to the ongoing conference.

## Listening to messages

---

When you have new messages, the phone displays a new-messages notification on the idle screen:

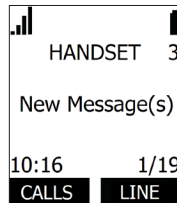

### To listen to your messages:

1. Press **MENU**. With **Message** highlighted, press **SELECT**.

The Message screen appears.



2. Press **▼** to highlight the desired account and press **SELECT**.

The handset dials the voicemail access number.

3. Follow the voice prompts to listen to your messages.

## Using the Directory

---

The handset has three lists of contacts. The **Local directory** is only available on your handset. The **Base directory** is usually maintained by your system administrator, and is available on all handsets. The **Blacklist** contains blocked numbers.

### To view a directory:

1. Press **MENU**. Press **▼** to scroll to **Directory** and press **SELECT**, or press **▲** when the phone is idle.

The Directory menu appears.

2. Press **▲** or **▼** to select the directory you wish to view, then press **SELECT**.
3. With **Review** selected, press **SELECT**.
4. Press **▼** or **▲** to browse through contacts.

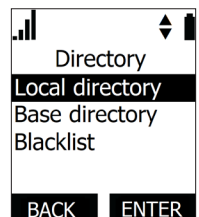

## To call a contact:

When viewing a directory entry, you can call a contact in the following ways.

1. Dial the phone number in the entry:
  - a. Press **TYPE** to cycle through work, mobile, and other numbers.
  - b. Press **DIAL** to call the contact.
2. Revise the phone number to dial before calling:
  - a. Press **MENU**.
  - b. Press ▼ to scroll to **Edit dial** and press **SELECT**.
  - c. Edit the number as required, then press **DIAL** .

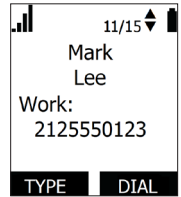

## To search a directory:

1. Press **MENU**. Press ▼ to scroll to **Directory** and press **SELECT**. The Directory menu appears.
2. Press ▲ or ▼ to select the directory to search, then press **SELECT**.
3. Press ▼ to scroll to **Search** and press **SELECT**.
4. Enter a name or number, then press **NEXT** .



## To add a new entry:

1. Press **MENU**. Press ▼ to scroll to **Directory** and press **SELECT**. The Directory menu appears.
2. Press ▲ or ▼ to select the directory to add a new entry to, then press **SELECT**.
3. Press ▼ to scroll to **Add new** and press **SELECT**.
4. Use the dial pad to enter the first name, last name, work, mobile, and other phone numbers. Press **NEXT** after entering each item.
5. Press **SELECT** to choose the ringer tone, then press **NEXT** .
6. Press **SELECT** to choose the dial line (account).
7. When you are done, press **SAVE** .



## To edit an entry:

1. When viewing the directory entry you wish to edit, press **MENU**.
2. With **Edit** highlighted, press **SELECT**.
3. Press ▲ or ▼ to select an item to edit.
4. Use the dial pad to change the first name, last name, work, mobile, and other phone numbers. Press **BACKSP** to delete characters.
5. Press **SELECT** to change the ringer tone and dial line (account).
6. When you are done editing, press **SAVE** .

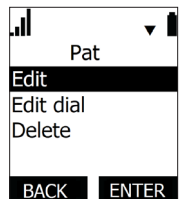

## To delete an entry:

1. When viewing the directory entry you wish to delete, press **MENU**.
2. Press ▼ to scroll to **Delete** and press **SELECT**.
3. Press **YES** on the delete confirmation screen.

#### To delete all entries:

1. Press **MENU**. Press ▼ to scroll to **Directory** and press **SELECT**. The Directory menu appears.
2. Press ▲ or ▼ to select the directory to delete, then press **SELECT**.
3. Press ▼ to scroll to **Delete all** and press **SELECT**.
4. Press **YES** on the delete all confirmation screen.



#### Using the Call History

The Call History contains lists of your missed, received, and dialed calls (you can also view dialed calls by pressing **REDIAL**). You can view, call and store list entries.

#### To view the Call History:

1. Press **MENU**. Press ▼ to scroll to **Call History** and press **SELECT**, or press ▼ when the phone is idle. The Call History menu appears.
2. Press ▼ or ▲ to highlight the desired list and press **SELECT**.
3. With **Review** highlighted, press **SELECT**.
4. Press ▼ or ▲ to view entries.

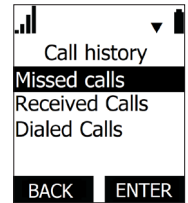

The Call History entry screen shows the time, date, name and number of the call, the number of entries in the folder, along with an icon indicating the type of call.



#### To call an entry:

When viewing a Call History entry, you can call the entry in the following ways.

1. Press **DIAL** to call the phone number in the entry.
2. Revise the phone number to dial before calling:
  - a. Press **MENU**.
  - b. With **Edit dial** highlighted, press **SELECT**.
  - c. Edit the number as required, then press **DIAL**.

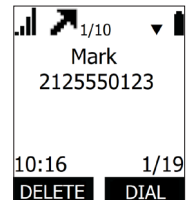

### To save an entry to a directory:

1. Press **MENU** when viewing a Call History entry.
2. Press ▼ to scroll to **Save To** and press **SELECT**. Press ▲ or ▼ to select the directory to save to, then press **ENTER**.
3. Use the dial pad to enter the first name, last name, work, mobile, and other phone numbers. Press **NEXT** after entering each item.
4. Press **SELECT** to choose the ringer tone, then press **NEXT**.
5. Press **SELECT** to choose the dial line (account).
6. When you are done, press **SAVE** to return to Call History.

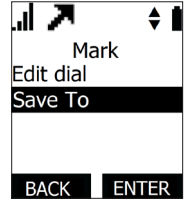

### To delete entries:

1. To delete the entry you are viewing, press **DELETE**.
2. To delete all entries:
  - a. In the main Call History menu, press ▲ or ▼ to select the list you wish to delete, then press **ENTER**.
  - b. Press ▼ to scroll to **Delete all** and press **SELECT**.
  - c. On the delete all confirmation screen, press **SELECT** to delete all, or press **CANCEL**.

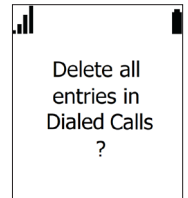

## Using Speed Dial

---

The speed dial feature allows you to program up to 10 numbers that you dial frequently. To dial a speed dial number, press and hold the dial pad key that matches the speed dial entry number (for entry 10, press and hold **0**).

### To program a Speed Dial number:

1. Press **MENU**.
2. Press ▼ to scroll to **Speed dial** and press **SELECT**.
3. Press ▼ or ▲ to select an empty slot, then press **SELECT**.



4. Use the dial pad to enter a name, and then press ▼.
5. Use the dial pad to enter a number, and then press ▼.
6. Press **SELECT** to choose the dial line (account), and then press **SAVE**.

### To edit existing Speed Dial entries:

1. Select the entry in the Speed Dial list then press **SELECT**.
2. Press ▼ or ▲ to select an item to edit.
3. Use the dial pad to change the name and number. Press **BACKSP** to delete characters.
4. Press **SELECT** to change the dial line (account).
5. When you are done editing, press **SAVE**.

### To delete existing Speed Dial entries:

1. Select the entry in the Speed Dial list, and then press **DELETE**.
2. Press **YES** on the delete confirmation screen.



# Configuring the Handset

You can configure the phone using one of two methods:

1. The **Features** and **User settings** menus on the phone.
2. The WebUI, which you access using your Internet browser.

This section describes settings you can change using your handset. For information about settings you can change on the WebUI, see "WebUI" on page 59.

The system administrator can configure additional settings, including Network settings, Provisioning, and the PIN code by using the **Admin settings** menu. For more information about this menu, see the *M100 KLE Administrator and Provisioning Manual*.

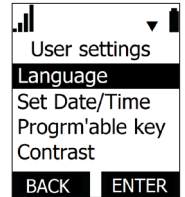
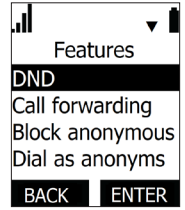

## Setting do not disturb

When Do Not Disturb (DND) is on for an account, calls to that account will be rejected.

### To turn DND on or off:

1. Press **MENU**.
2. Press **▼** to scroll to **Features** and press **SELECT**.
3. With **DND** highlighted, press **SELECT**.
4. Press **▲** or **▼** to select which account DND should apply to\*, then press **SELECT**.
5. Press **▲** or **▼** to choose **On** or **Off**.
6. Press **SET** to save.

\* Note that DND will apply to all handsets assigned the account.

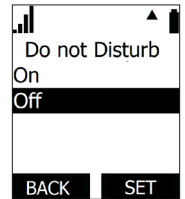

## Setting call forwarding

Calls can be forwarded to another phone number always, only when busy, or after a set number of rings.

### To set call forward:

1. Press **MENU**.
2. Press **▼** to scroll to **Features** and press **SELECT**.
3. Press **▼** to scroll to **Call forwarding** and press **SELECT**.
4. Press **▲** or **▼** to select which account Call forward should apply to\*, then press **SELECT**.
5. Press **▲** or **▼** to choose the desired option:
  - Always
  - Busy
  - No answer
6. Press **SELECT**.

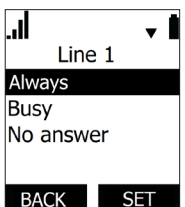

7. On the next screen, with **Set On/Off** highlighted, press **SELECT**.
8. Press ▲ or ▼ to choose **On** or **Off**, and press **SELECT**.
9. Press ▼ to scroll to **Phone number** and press **SELECT**.
10. Enter the number to which you would like to forward calls.
11. Press **BACKSP** to move the cursor back and delete the previous number.
12. Press **SAVE**.
13. If you selected **No answer** earlier:
  - a. Press ▼ to scroll to **No ans. delay**.
  - b. Press ▲ or ▼ to choose the number of rings between 1 and 10.
  - c. Press **SELECT**.

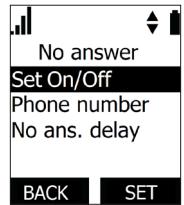

\* Note that Call forward will apply to all handsets assigned the account.

### Blocking anonymous calls

Calls without Caller ID information will be rejected and the handset will not ring.

#### To block anonymous callers:

1. Press **MENU**.
2. Press ▼ to scroll to **Features** and press **SELECT**.
3. Press ▼ to scroll to **Block anonymous** and press **SELECT**.
4. Press ▲ or ▼ to select which account Block anonymous should apply to\*, then press **SELECT**.
5. Press ▲ or ▼ to choose **On** or **Off**.
6. Press **SET** to save.

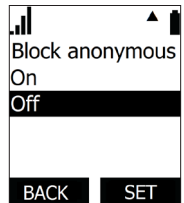

\* Note that Block anonymous will apply to all handsets assigned the account.

### Dialing anonymously

When this feature is enabled, your phone will make anonymous outgoing calls.

#### To dial as an anonymous caller:

1. Press **MENU**.
2. Press ▼ to scroll to **Features** and press **SELECT**.
3. Press ▼ to scroll to **Dial as anonyms** and press **SELECT**.
4. Press ▲ or ▼ to select which account Dial as anonymous should apply to\*, then press **SELECT**.
5. Press ▲ or ▼ to choose **On** or **Off**.
6. Press **SET** to save.

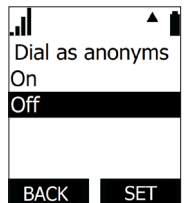

\* Note that Dial as anonymous will apply to all handsets assigned the account.

## Setting missed-call alerts

---

When missed-call alerts are enabled, an alert will display on the idle screen whenever you do not answer an incoming call.

### To turn missed-call alerts on or off:

1. Press **MENU**.
2. Press ▼ to scroll to **Features** and press **SELECT**.
3. Press ▼ to scroll to **Miss call alert** and press **SELECT**.
4. Press ▲ or ▼ to choose **Show alert** or **Hide alert**.
5. Press **SET**.

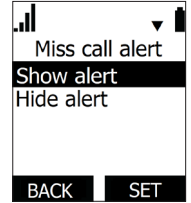

## Setting call waiting

---

When call-waiting alerts are enabled, an alert will display on-screen whenever you receive an incoming call during an active call.

### To turn call-waiting alerts on or off:

1. Press **MENU**.
2. Press ▼ to scroll to **Features** and press **SELECT**.
3. Press ▼ to scroll to **Call waiting** and press **SELECT**.
4. Press ▲ or ▼ to choose **Show alert** or **Hide alert**.
5. Press **SET**.



## Viewing handset status

---

In the Status menu, you can view information on the LAN network your phone system is connected to, the registration status of your SIP accounts, or view the software version of your handset. You may need this information for troubleshooting purposes.

### To view the Status menu:

1. Press **MENU**.
2. Press ▼ to scroll to **Status** and press **SELECT**.
3. Press ▼ to scroll to either **Network**, **Line**, or **Product Info**, and press **SELECT**.

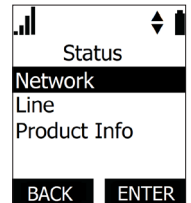

### To view the software version of your phone:

1. From the **Status** menu, select **Product Info** and press **SELECT**.
2. With **Handset** highlighted, press **SELECT**.
3. Scroll down to view the software version.

## Setting the language

---

1. Press **MENU**.
2. Press ▼ to scroll to **User settings** and press **SELECT**.
3. With **Language** highlighted, press **SELECT**.
4. Press ▲ or ▼ to choose the desired language.
5. Press **SET** to save.

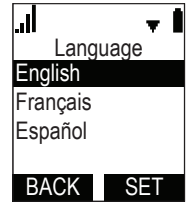

## Setting the date and time

---

1. Press **MENU**.
2. Press ▼ to scroll to **User settings** and press **SELECT**.
3. Press ▼ to scroll to **Set Date/Time** and press **SELECT**.
4. On the Set date screen, set the values for MM, DD, and YY. The currently selected value is flashing.
  - a. Press ▲ or ▼ to select a number, or use the dial pad to enter a number.
  - b. Press **NEXT** to go to the next value.
  - c. Press **BACK** to go back to the previous value.
5. On the Set time screen, set the values for HH, MM and AM/PM. The currently selected value is flashing.
  - a. Press ▲ or ▼ to select a number or AM/PM, or use the dial pad to enter a number.
  - b. Press **SAVE** to go to the next value.
  - c. Press **BACK** to go back to the previous value.

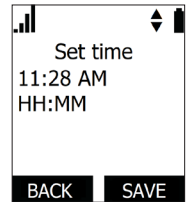
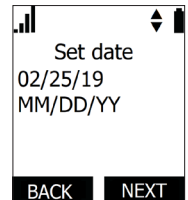

## Setting the handset name

---

You can change the handset name from the default HANDSET.

### To change the handset name:

1. Press **MENU**.
2. Press ▼ to scroll to **User settings** and press **SELECT**.
3. Press ▼ to scroll to **Phone rename** and press **SELECT**.
4. Press **BACKSP** to move the cursor back and delete the previous name.
5. Enter the new name using the dial pad.
6. Press **SET** when complete.

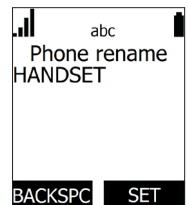

## Configuring the programmable keys

You can configure the Programmable Keys on the handset.

### To configure the line keys (L1-L4):

1. Press **MENU**.
2. Press ▼ to highlight **User settings** and then press **SELECT**.
3. Press ▼ to highlight **Programmable key** and then press **SELECT**.
4. With **Line key** highlighted, press **SELECT**.
5. Press ▼ or ▲ to select a line key and then press **EDIT**.
6. Press **SELECT** to choose the Type of key.  
For a list of available Types, see "Programmable Key Types" on page 54.
7. If the key has another setting (as indicated by ▼), press ▼ and then press **SELECT** to choose the Value or Account.
8. Press **SAVE**.
9. To configure another line key, go to step 5.

### To configure the soft keys:

1. Press **MENU**.
2. Press ▼ to highlight **User settings** and then press **SELECT**.
3. Press ▼ to highlight **Programmable key** and then press **SELECT**.
4. Press ▼ to highlight **Softkey** and then press **SELECT**.
5. Press ▼ or ▲ to select a soft key and then press **EDIT**.
6. Press **SELECT** to choose the Type of key.  
For a list of available Types, see "Programmable Key Types" on page 54.
7. If the key has another setting (as indicated by ▼), press ▼ and then press **SELECT** to choose the Account.
8. Press **SAVE**.
9. To configure another soft key, go to step 5.

### To configure the hard keys:

1. Press **MENU**.
2. Press ▼ to highlight **User settings** and then press **SELECT**.
3. Press ▼ to highlight **Programmable key** and then press **SELECT**.
4. Press ▼ to highlight **Hardkey** and then press **SELECT**.
5. Press ▼ or ▲ to select a hard key and then press **EDIT**.
6. Press **SELECT** to choose the Type of key.  
For a list of available Types, see "Programmable Key Types" below.

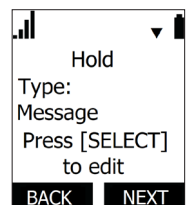
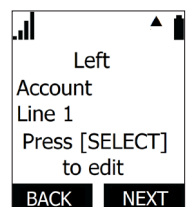
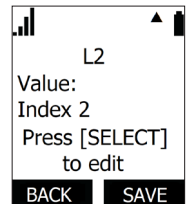
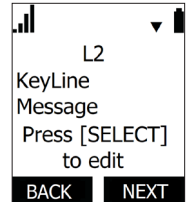
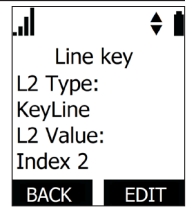

7. If the key has another setting (as indicated by ▼), press ▼ and then press **SELECT** to choose the Account.
8. Press **SAVE**.
9. To configure another hard key, go to step 5.

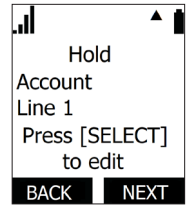

## Programmable Key Types

You can assign functions to line keys (**L1, L2, L3, L4**), soft keys (located above the **L1** and **L2** keys), and hard keys (**HOLD, ▲, ▼, INT, MUTE**).

Keys can have identical functions, depending on the "Type" of key. For example, you can assign keys for Key System Emulation so that you can manage your own held calls and shared calls within the system. You can also assign several "Line"-type keys to Account 1 so that you can manage multiple calls on Account 1. For programmable key default settings, see "Programmable Key Types" on page 54.

Type	Description
N/A	Configures the key so it does not have a function. If you press the key, nothing will happen.
KeyLine*	Configures the key for Key System Emulation. You can manage your own held calls and shared calls within the system. The key LED will change according to call activity. Select the desired line index number.
Line*	Configures the key for accessing a line. You can make calls or answer calls by pressing these keys. The key LED will change according to call activity. Select the desired Account number.
Call list	Configures the key to access the Call List. You can then press the key to view the Call List.
Directory	Configures the key to access the Directory menu. You can then press the key to view the Directory menu.
Call History	Configures the key to access the Call History list. You can then press the key to view the Call History list.
Redial	Configures the key to access the Redial list. You can then press the key to view the Redial list.
Message	Configures the key to access the Message menu. You can then press the key to view the Message menu.
Do Not Disturb	Configures the key to turn Do Not Disturb on or off.

\* This Type is only available for line keys (**L1** to **L4**).

Type	Description
Call Forward All	Configures the key to turn Call Forward All on or off. Select the line for which Call Forward All will apply. Ensure that you also configure Call Forward settings on the WebUI Call Settings page.
Call Forward Busy	Configures the key to turn Call Forward Busy on or off. Select the account for which Call Forward Busy will apply. Ensure that you also configure Call Forward settings on the WebUI Call Settings page.
Call Forward No Answer	Configures the key to turn Call Forward No Answer on or off. Select the account for which Call Forward No Answer will apply. Ensure that you also configure Call Forward settings on the WebUI Call Settings page.

### Line key lights

The line key lights (**L1** to **L4**) indicate call status and other information.

Type	Light Activity	Description
KeyLine*	Steady GREEN	<b>Shared Call operation:</b> On a call or dialing; OR Shared call is active on your handset or another handset/ deskset
	Quickly flashing GREEN	Ringing incoming call
	Slowly flashing GREEN	Shared call is on hold on your handset or another handset/ deskset
Line	Steady GREEN	<b>Private Call operation**:</b> On a call or dialing
	Quickly flashing GREEN	Ringing incoming call
	Slowly flashing GREEN	Held call
Do Not Disturb	Off	DND is off
	Steady GREEN	DND or DND All is on
Call forward	Off	Call forward All is off
	Steady GREEN	Call forward All is on

\* For more information, see "Using Key System Emulation" on page 36.

\*\* Calls made via the Line feature have exactly the same behavior as a KeyLine call except:

- 1) Calls are not visible in system devices' Call list or L1-L4 keys LED.
- 2) Calls therefore cannot be barged by system devices via the L1-L4 keypress.

## Setting the screen contrast

You can change the contrast of text and graphics on the handset LCD.

### To change the LCD text contrast:

1. Press **MENU**.
2. Press ▼ to scroll to **User settings** and press **SELECT**.
3. Press ▼ to scroll to **Contrast** and press **SELECT**.
4. Press ▼ or ▲ to choose a contrast level between 1 and 7.
5. Press **SET**.

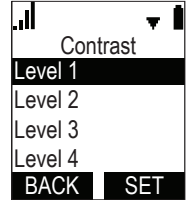

## Backlight

You can set the deskset LCD backlight to be off when in idle, or set it to turn on or off continuously.

### To set the LCD backlight:

1. Press **MENU**.
2. Press ▼ to highlight **User settings** and then press **SELECT**.
3. Press ▼ to highlight **LCD Backlight** and then press **SELECT**.
4. Press ▼ or ▲ to choose **Backlight Time**, **During idle** or **Being triggered\***.
  - If you select **Backlight Time**, press ▼ or ▲ to choose the timeout period between 10 seconds and 60 seconds.
  - If you select **During idle** or **Being triggered**, press ▼ or ▲ to choose **On** or **Off**.
5. Press **SET** to save.

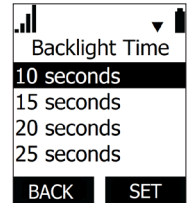
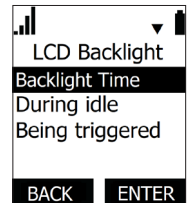

### \* Notes:

- If **During idle** is on and **Being triggered** is off, the LCD backlight always lights up.
- If **During idle** is off and **Being triggered** is on, the LCD backlight turns off after being idle for as long as the set timeout period.
- If **During idle** and **Being triggered** are both off, the LCD backlight is always off.



## Setting the ringer tone and volume

---

**TIP:** Fast way to set ringer volume: When phone is idle, press **VOLUME -** or **+** on the side of the handset.

### To set the ringer tone and volume:

1. Press **MENU**.
2. Press **▼** to scroll to **User settings** and press **SELECT**.
3. Press **▼** to scroll to **Ringers** and press **SELECT**.
4. To change the ringer volume:
  - a. Highlight **Ringer Volume** and press **SELECT**.
  - b. Press **▼** or **▲** to change the volume level as desired.
  - c. Press **SET** to save.
5. To change the ringer tone:
  - a. Press **▼** to scroll to **Ringer Tone** and press **SELECT**.
  - b. Press **▼** or **▲** to select an account, then press **ENTER**.
  - c. Press **▼** or **▲** to select a ringer tone.
  - d. Press **SELECT** to save.

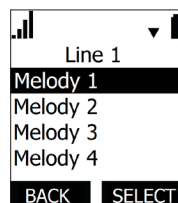
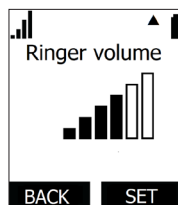

## Turning low battery tone on or off

---

1. Press **MENU**.
2. Press **▼** to scroll to **User settings** and press **SELECT**.
3. Press **▼** to scroll to **Low batt tone** and press **SELECT**.
4. Press **▼** or **▲** to choose **On** or **Off**.
5. Press **SET** to save.

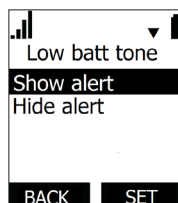

## Turning link lost tone on or off

---

1. Press **MENU**.
2. Press **▼** to scroll to **User settings** and press **SELECT**.
3. Press **▼** to scroll to **Link lost tone** and press **SELECT**.
4. Press **▼** or **▲** to choose **On** or **Off**.
5. Press **SET** to save.

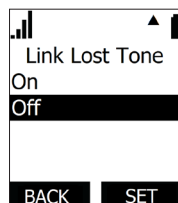

## Turning key tones on or off

---

1. Press **MENU**.
2. Press **▼** to scroll to **User settings** and press **SELECT**.
3. Press **▼** to scroll to **Key Tone** and press **SELECT**.
4. Press **▼** or **▲** to choose **On** or **Off**.
5. Press **SET** to save.

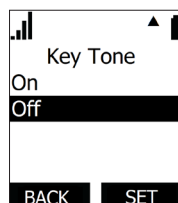

## **Registering or deregistering your handset**

---

You can register or deregister your handset using the handset menu.

Follow the instructions in "Registering the handset to the base station" on page 22 and "Deregistering the handset" on page 23.

# WebUI

## Using the WebUI

---

Use an Internet browser to access the Web User Interface (WebUI) that resides on your base station. After you log on to the WebUI, you can configure the following features:

- Call Settings
- User Preferences
- Base Directory
- Blacklist
- User Password

The WebUI also has a System Status and Handset Status page, where you can view network status and registration information about your handset.

### To access the WebUI:

1. Ensure that your computer is connected to the same network as your base station.
2. Find the IP address of your base station:
  - a. When the phone is idle, press **MENU**.
  - b. Press ▼ to highlight **Status**, and then press **SELECT**. The Status menu appears:

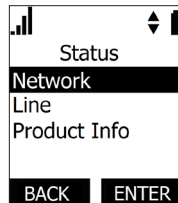

- c. On the Status menu, ensure that **Network** is highlighted, and then press **SELECT**. The Network screen appears:

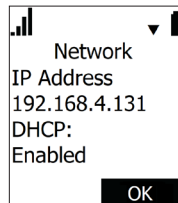

- d. On the Network screen, note the IP Address.
3. On your computer, open an Internet browser. Depending on your browser, some of the pages presented here may look different and have different controls.
  4. Type the phone IP address in the browser address bar and press **ENTER** on your computer keyboard:



A Login window appears.

5. Under **User Name**, enter **user**.
6. Under **Password**, enter **user**, or your own password, if you have created one. You can create or change a password after you log on.
7. Click **Log In / OK**. The WebUI appears.

STATUS	STATUS	SYSTEM	CONTACTS	SERVICING
<b>System Status</b>				
<b>Handset Status</b>	<p><b>General</b></p> <p>Model: M100 KLE            Serial Number: 07900002999            MAC Address: 14:AE:DB:2A:40:1D            Link Status: Connected            Boot Version: 1.13            Software Version: 2.10.37.9c8e            V-Series: 2.10.37.9c8e            Hardware Version: HW1.1            EMC Version: 0            Network Time Settings: us.pool.ntp.org</p> <p><b>Account Status</b></p> <p>Account 1: Registered            Account 2: Registered            Account 3: Not Registered            Account 4: Not Registered            Account 5: Not Registered            Account 6: Not Registered            Account 7: Not Registered            Account 8: Not Registered</p>			

Click topics from the navigation bar at the top of the page, and then click the desired setting on the left side of the WebUI to see the page for that setting. You view and change settings in two different types of fields: drop-down lists and entry fields into which you type information. For your security, the WebUI times out after 10 minutes, so if it is idle for that time, you must log on again.

The remaining procedures in this section assume that you have already logged on to the WebUI.

## System Status

The System Status page shows:

- **General** information about your phone, including model, MAC address, and firmware version.
- **Account Status** information about your SIP account registration.
- **IPv4** and **IPv6** network information regarding your phone's network address and network connection.

The System Status page has no settings that you can change. You may need some of the status information for troubleshooting purposes.

STATUS	STATUS	SYSTEM	CONTACTS	SERVICING
<b>System Status</b> <b>Handset Status</b>	<b>General</b>			
	Model:	M100 KLE		
	Serial Number:	07900002999		
	MAC Address:	14:AE:DB:2A:40:1D		
	Link Status:	Connected		
	Boot Version:	1.13		
	Software Version:	2.10.37.9c8e		
	V-Series:	2.10.37.9c8e		
	Hardware Version:	HW1.1		
	EMC Version:	0		
	Network Time Settings:	us.pool.ntp.org		
	<b>Account Status</b>			
	Account 1:	Registered		
	Account 2:	Registered		
	Account 3:	Not Registered		
	Account 4:	Not Registered		
	Account 5:	Not Registered		
	Account 6:	Not Registered		
	Account 7:	Not Registered		
	Account 8:	Not Registered		
	<b>IPv4</b>			
	IP Mode:	dhcp		
	IP Address:	10.88.50.107		
	Subnet Mask:	255.255.0.0		
	Gateway:	10.88.3.149		
	Primary DNS:	10.88.162.10		
	Secondary DNS:	10.88.162.6		
	VPN:	Disabled		
	<b>IPv6</b>			
	IP Mode:	disable		
	IP Address:	::		
	Prefix:	0		
	Gateway:	fe80::217:c5ff:fe42:1c7c		
	Primary DNS:			
	Secondary DNS:			

## Handset Status

The Handset Status page shows registration information for your handsets.

STATUS	SYSTEM	CONTACTS	SERVICING
System Status	<b>Handset Status</b>		
Handset Status	<b>Name</b>	<b>Registration Status</b>	
	1:	HANDESET	Not Registered
	2:	DESKSET	Registered
	3:	HANDESET	Registered
	4:	HANDESET	Not Registered
	5:	HANDESET	Not Registered
	6:	HANDESET	Not Registered
	7:	HANDESET	Not Registered
	8:	HANDESET	Not Registered
	9:	HANDESET	Not Registered
	10:	HANDESET	Not Registered

The Handset Status page has no settings that you can change. You may need some of the status information for troubleshooting purposes.

## Call Settings

To view the call settings, click **SYSTEM** in the WebUI header, and then click **Call Settings** in the sidebar. You can configure call settings for each account that is available to your phone. Click **Account 1**, **Account 2**, and so on to select the call settings page for the desired account.

Call Settings include Do Not Disturb and Call Forward settings. You can also set Do Not Disturb and Call Forward using the handset. See "Configuring the Handset" on page 49.

When you have finished changing settings on this page, click **Save** to save them.

SYSTEM	STATUS	SYSTEM	CONTACTS	SERVICING
Call Settings	<b>SYSTEM CALL SETTINGS 1</b>			
Account 1	<b>General Call Settings</b>			
Account 2	<input type="checkbox"/> Anonymous Call Reject			
Account 3	<input type="checkbox"/> Enable Anonymous Call			
Account 4	<b>Do Not Disturb</b>			
Account 5	<input type="checkbox"/> Enable DND			
Account 6	<b>Call Forward</b>			
Account 7	<input type="checkbox"/> Enable Call Forward Always			
Account 8	Target Number: <input type="text"/>			
User Preferences	<input type="checkbox"/> Enable Call Forward Busy			
	Target Number: <input type="text"/>			
	<input type="checkbox"/> Enable Call Forward No Answer			
	Target Number: <input type="text" value="2913"/>			
	Delay: <input type="text" value="1 ring"/>			
	<input type="button" value="Save"/>			

## General Call Settings

Setting	Description
Anonymous Call Reject	Select to block incoming calls that have no caller ID.
Enable Anonymous Call	Select to make outgoing calls that remove your own caller ID information.

## Do Not Disturb Settings

Setting	Description
Enable DND	Turns Do Not Disturb on or off.

## Call Forward Settings

Setting	Description
Enable Call Forward Always	Select to enable call forwarding for all calls on that account.
Target Number	Enter a number to which all calls will be forwarded.
Enable Call Forward Busy	Select to enable call forwarding for calls when you are on another call on that account.
Target Number	Enter a number to which calls will be forwarded when the account is busy.
Enable Call Forward No Answer	Select to enable call forwarding for unanswered calls on that account.
Target Number	Enter a number to which unanswered calls will be forwarded.
Delay	Select the number of rings before unanswered calls are forwarded. Range: 1 to 10 rings Default: 6 rings

## User Preferences

On the User Preferences page, you can configure the WebUI language.

After changing the setting on this page, click **Save** to save.

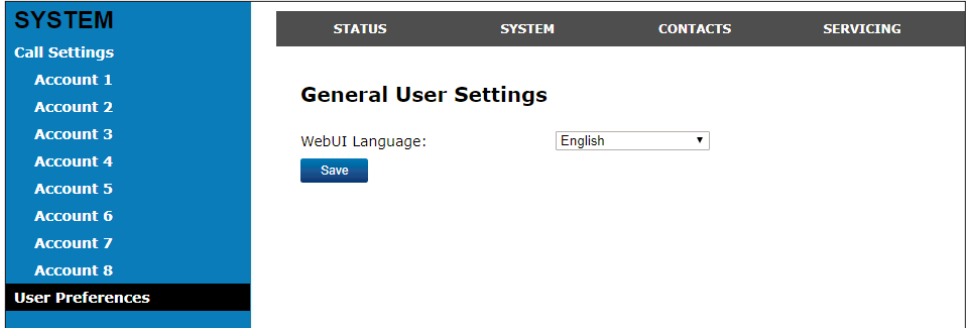

The screenshot shows a web interface for 'User Preferences'. On the left is a blue sidebar menu with 'SYSTEM' at the top, followed by 'Call Settings', 'Account 1' through 'Account 8', and 'User Preferences' at the bottom. The main content area has a dark header with 'STATUS', 'SYSTEM', 'CONTACTS', and 'SERVICING'. Below the header, the title 'General User Settings' is displayed. The 'WebUI Language:' setting is shown with a dropdown menu currently set to 'English' and a blue 'Save' button below it.

### General User Settings

Setting	Description	Range	Default
WebUI Language	Sets the language that appears on the WebUI.	Any language supported by your phone. For example, English, French, Spanish, etc.	English



## Base Directory

To view the base directory, click **CONTACTS** in the WebUI header, and then click **Base directory** in the sidebar.

On the Base directory page, you can manage your base directory entries. You can sort, edit, delete, and add contact information for up to 1,000 entries. The page also allows you to export your phone's base directory or import a base directory file. The export function lets you back up your contacts to your computer.

The Base directory lists entries across several pages. Click **Next**, **First**, **Last**, or a page number to view the desired page of entries.

**Note:** You can also use the phone menu to manage your base directory entries. For more information, see "Using the Directory" on page 44.

**CONTACTS**

- Base Directory
- Blacklist
- LDAP
- Remote XML

STATUS SYSTEM NETWORK CONTACTS SERVICING

### Base Directory

Select All  Sort By Last Name

Total: 20	First Name	Last Name	Ringer Tone	Work	Mobile	Other	Account	
<input type="checkbox"/>	Angela	Martin	0			7325550118	1	Edit
<input type="checkbox"/>	Bronwyn	McDonald	0			2325550140	1	Edit
<input type="checkbox"/>	Charlie	Johnson	0			5550198	1	Edit
<input type="checkbox"/>	Dale	Appleton	0	6045550135			1	Edit
<input type="checkbox"/>	David	Carter	3	2325550177		2325550194	2	Edit
<input type="checkbox"/>	David	Swerdlow	0	2325550172			1	Edit
<input type="checkbox"/>	Elkhart	Taxi	0	6045550155			1	Edit
<input type="checkbox"/>	Graham	Bail	0	2325550176			1	Edit
<input type="checkbox"/>	Kathryn	Dolphy	0	6045550195			1	Edit
<input type="checkbox"/>	Linda	Miller	0	6045550117			2	Edit
<input type="checkbox"/>	Lydia	Braithwaite	0			2325550157	1	Edit
<input type="checkbox"/>	Martin	Meyers	0			2325550122	1	Edit
<input type="checkbox"/>	Mary	Williams	0	604555015	6045550146		1	Edit
<input type="checkbox"/>	Richard	Serling	0	6045550141	7875550181		2	Edit
<input type="checkbox"/>	Robert	Brown	2	6045550105			2	Edit
<input type="checkbox"/>	Sandro	Voss	0			2325550149	1	Edit
<input type="checkbox"/>	Stefan	Wheeler	0	2325550161			1	Edit
<input type="checkbox"/>	Susan	Balance	0	6045550170			1	Edit
<input type="checkbox"/>	Terry	Ng	0	2325550187			1	Edit
<input type="checkbox"/>	Ursula	Baldwin	0			6045550166	1	Edit

First 1 Last

Delete Selected Entries Add New Entry

Clear Directory

### Import Base Directory

No file chosen Choose File

Import XML

First line is header, skip Import CSV

### Export Base Directory

Export XML

Export CSV

## Base directory

Click	To...
<a href="#">Sort By Last Name</a>	Sort the list by last name.
<a href="#">Sort By First Name</a>	Sort the list by first name.
<a href="#">Edit</a>	Edit information for an entry.
<a href="#">Last</a>	View the last page of entries.
<a href="#">Next</a>	View the next page of entries.
<a href="#">Delete Selected Entries</a>	Delete selected entries from the directory. Click <b>Select All</b> to select every entry on the page you are viewing.
<a href="#">Add New Entry</a>	Add a new directory entry.
<a href="#">Clear Directory</a>	Delete all Directory entries

### To add a new directory entry:

1. Click **Add New Entry**.

The **Create Local Directory Entry** page appears.

2. Enter the required information. At minimum, a first and last name are required.

Setting	Description	Range	Default
First Name	Enter the appropriate names in these fields.	N/A	N/A
Last Name			
Ringer Tone	Sets a unique ringer tone for calls from this directory entry.	Auto, Tone 1–10	Auto
Account	Sets the account used when you dial this directory entry.	Default Account, Account 1–Account 8	Default Account
Work Number	Enter the appropriate numbers in these fields.	N/A	N/A
Mobile Number			
Other Number			

3. Click **Save**.

## To edit a directory entry:

1. Click Edit for the entry you want to edit.

The **Edit Local Directory Entry** page appears.

CONTACTS	STATUS	SYSTEM	CONTACTS	SERVICING
Base Directory Blacklist Remote XML	<b>Edit Local Directory Entry</b>			
First Name:	<input type="text" value="John"/>			
Last Name:	<input type="text" value="Smith"/>			
Ringer Tone:	<input type="text" value="Auto"/>			
Account:	<input type="text" value="Account 1"/>			
Work Number:	<input type="text" value="5551231234"/>			
Mobile Number:	<input type="text" value="5556729863"/>			
Other Number:	<input type="text" value="5556126549"/>			
<input type="button" value="Save"/>				

2. Edit or add the desired information.
3. Click **Save**.

## Import Base directory

You can import an existing base directory file. Importing a directory file replaces all your previous base directory entries. After importing a directory file, you can add, edit, or delete entries as desired.

**Note:** Directory files are .xml or .csv files containing contacts and contact information. For more information about creating or editing a directory file, consult your system administrator.

## To import a base directory file:

1. Click **Choose File**.
2. In the **Choose File to Upload** window, navigate to the directory file.
3. Click the file, and then click **Open**.
4. If you are importing an XML file, click **Import XML**.
5. If you are importing a comma-separated value (CSV) file:
  - a. If the first line of the CSV file is a header line, click the **First line is header, skip** checkbox.
  - b. Click **Import CSV**.

## Export Base directory

You can export the directory and save it as an .xml file on your computer.

## To export the base directory:

1. Click **Export XML or Export CSV**.
2. If prompted by your browser, save the file to the desired location on your computer.

## Blacklist

To view the Blacklist, click **CONTACTS** in the WebUI header, and then click **Blacklist** in the sidebar.

The Blacklist directory is identical to the Base directory, except that you cannot configure an incoming ringer tone.

## Remote XML

On the Remote XML page, you can configure up to three server-hosted Remote XML directories to appear on the Directory menu of your deskset.

CONTACTS			
STATUS	SYSTEM	CONTACTS	SERVICING
<b>Base Directory</b>			
<b>Blacklist</b>			
<b>Remote XML</b>			
<b>Remote XML Directories</b>			
ID	Name	Remote XML URI	Enable Incoming/Outgoing Call Lookup
1	<input type="text"/>	<input type="text"/>	<input type="checkbox"/>
2	<input type="text"/>	<input type="text"/>	<input type="checkbox"/>
3	<input type="text"/>	<input type="text"/>	<input type="checkbox"/>
<input type="button" value="Save"/>			

For more information about configuring Remote XML directories, see the *M100 KLE Administrator and Provisioning Manual*.

## Security

On the Security page, you can change the User Password that you use to access the WebUI.

SERVICING			
STATUS	SYSTEM	CONTACTS	SERVICING
<b>Security</b>			
<b>Passwords</b>			
<b>User Password</b>			
Enter Old Password: <input type="text"/>			
Enter New Password: <input type="text"/>			
Re-enter New Password: <input type="text"/>			
<input type="button" value="Save"/>			

After changing your password, click **Save**.

# Troubleshooting

If you have difficulty with your handset, please try the suggestions below.

For customer service, visit our website at [www.snomamericas.com](http://www.snomamericas.com).

## General issues

---

### Handset does not work at all (LCD is black)

- Confirm the battery is installed and charged correctly.
- Place the handset into its charger. Ensure the charger is securely plugged into an outlet not controlled by a wall switch.
- If the battery is completely depleted, it can take up to 10 minutes to charge the battery before the low battery icon displays on screen.

### My caller ID isn't working.

- Caller ID is a subscription service. Your telephone service provider may require subscription to this service for this feature to work.
- The caller must be calling from an area that supports caller ID.
- Both your telephone service provider and your caller's service provider must use caller ID compatible equipment.

### Handset registration is not working

- Place the handset in the charger for a few seconds, remove it and repeat the registration procedure.
- Ensure the handset is within range of the base station.

### Cannot make external calls

- Check if your SIP account is registered (Press **MENU** → **Status** → **Line** and select an account. Check that the status reads **Registered**).
- You might be out of range of the base station. Try moving closer. If you see an idle screen with no alerts, then your handset is successfully communicating with the base station.

### Handset does not receive incoming calls

- Ensure that **Do Not Disturb** and **Call Forward All** are turned off.
- Check if your SIP account is registered (Press **MENU** → **Status** → **Line** and select an account. Check that the status reads **Registered**).
- You might be out of range of the base station. Try moving closer.

### Cannot locate handset using base station

- The handset may not be registered.
- If the handset battery is dead or the handset is out of range, the locator tone will not sound.

## Poor audio quality. Speech is cutting out.

- You may be close to being out of range of the base station. Try moving closer.
- Other electronic products can cause interference with your handset. Try installing the base station far away from devices such as TVs, microwaves, or other cordless devices, including other handsets.
- If the problem persists, contact your system administrator.

## Technical Specifications

RF frequency band	1921.536–1928.448 MHz
Channels	5
Operating temperature	32–104 °F (0–40 °C)
Power requirements	Base station: 5.0 Vdc @ 800 mA Handset charger: 6.0 Vdc @ 100 mA Handset: 2.4 V 550 mAh, Ni-MH battery pack
Power over Ethernet	IEEE 802.3at supported, class 2
Ethernet network port	10/100 Mbps RJ-45 port

## Special characters

### Entering special characters

When entering text using the dial pad, the following special characters are available. Press the 1, 0, or pound sign (#) keys to enter special characters.

Key	Characters
1	~ ^ ` % ! & - _ + =   1
0	0 ; , ? . @ * 0
#	( ) [ ] { } < > / \ #

Press \* (star) to switch between uppercase and lowercase/European characters.

# Maintenance

## Taking care of your telephone

---

- Your base station and cordless handset contain sophisticated electronic parts, so you must treat them with care.
- Avoid rough treatment.
- Place the handset down gently.
- Save the original packing materials to protect your products if you ever need to ship them.

## Avoid water

---

- You can damage your cordless telephone if it gets wet. Do not use the handset in the rain, or handle it with wet hands. Do not install the base station and handset near a sink, bathtub or shower.

## Electrical storms

---

- Electrical storms can sometimes cause power surges harmful to electronic equipment. For your own safety, take caution when using electric appliances during storms.

## Cleaning your telephone

---

- Your products have a durable plastic casing that should retain its luster for many years. Clean it only with a soft cloth slightly dampened with water or a mild soap.
- Do not use excess water or cleaning solvents of any kind.

Remember that electrical appliances can cause serious injury if used when you are wet or standing in water. If the telephone base should fall into water, DO NOT RETRIEVE IT UNTIL YOU UNPLUG THE POWER CORD FROM THE WALL, then pull the unit out by the unplugged cord.

## Deregistering the handset

---

Before using the handset with a different base station, you must deregister the handset from the base station to which it is currently registered.

# Appendix - GNU General Public License

## COPYRIGHT NOTICE AND WARRANTY DISCLAIMER

I.

This Product contains Software applicable to GNU General Public License, Version 2 which can be used freely.

II.

Towards the licensor of this Software the following liability is disclaimed:

This program is distributed in the hope that it will be useful, but WITHOUT ANY WARRANTY; without even the implied warranty of MERCHANTABILITY or FITNESS FOR A PARTICULAR PURPOSE. See the GNU General Public License for more details.

III.

The GNU General Public License is as follows:

### GNU GENERAL PUBLIC LICENSE

Version 2, June 1991

Copyright (C) 1989, 1991  
Free Software Foundation, Inc.  
59 Temple Place, Suite 330  
Boston, MA 02111-1307, USA

Everyone is permitted to copy and distribute verbatim copies of this license document, but changing it is not allowed.

#### Preamble

The licenses for most software are designed to take away your freedom to share and change it. By contrast, the GNU General Public License is intended to guarantee your freedom to share and change free software--to make sure the software is free for all its users. This General Public License applies to most of the Free Software Foundation's software and to any other program whose authors

commit to using it. (Some other Free Software Foundation software is covered by the GNU Library General Public License instead.) You can apply it to your programs, too.

When we speak of free software, we are referring to freedom, not price. Our General Public Licenses are designed to make sure that you have the freedom to distribute copies of free software (and charge for this service if you wish), that you receive source code or can get it if you want it, that you can change the software or use pieces of it in new free programs; and that you know you can do these things.

To protect your rights, we need to make restrictions that forbid anyone to deny you these rights or to ask you to surrender the rights. These restrictions translate to certain responsibilities for you if you distribute copies of the software, or if you modify it. For example, if you distribute copies of such a program, whether gratis or for a fee, you must give the recipients all the rights that you have. You must make sure that they, too, receive or can get the source code. And you must show them these terms so they know their rights.

We protect your rights with two steps: (1) copyright the software, and (2) offer you this license which gives you legal permission to copy, distribute and/or modify the software.

Also, for each author's protection and ours, we want to make certain that everyone understands that there is no warranty for this free software. If the software is modified by someone else and passed on, we want its recipients to know that what they have is not the original, so that any problems introduced by others will not reflect on the original authors' reputations.

Finally, any free program is threatened constantly by software patents. We wish to avoid the danger that redistributors of a free program will individually obtain patent licenses, in effect making the program proprietary. To prevent this, we have made it clear that any patent must be licensed for everyone's free use or not licensed at all.



The precise terms and conditions for copying, distribution and modification follow.

## GNU GENERAL PUBLIC LICENSE

### TERMS AND CONDITIONS FOR COPYING, DISTRIBUTION AND MODIFICATION

0. This License applies to any program or other work which contains a notice placed by the copyright holder saying it may be distributed under the terms of this General Public License. The "Program", below, refers to any such program or work, and a "work based on the Program" means either the Program or any derivative work under copyright law: that is to say, a work containing the Program or a portion of it, either verbatim or with modifications and/or translated into another language. (Hereinafter, translation is included without limitation in the term "modification".) Each licensee is addressed as "you".

Activities other than copying, distribution and modification are not covered by this License; they are outside its scope. The act of running the Program is not restricted, and the output from the Program is covered only if its contents constitute a work based on the Program (independent of having been made by running the Program). Whether that is true depends on what the Program does.

1. You may copy and distribute verbatim copies of the Program's source code as you receive it, in any medium, provided that you conspicuously and appropriately publish on each copy an appropriate copyright notice and disclaimer of warranty; keep intact all the notices that refer to this License and to the absence of any warranty; and give any other recipients of the Program a copy of this License along with the Program.

You may charge a fee for the physical act of transferring a copy, and you may at your option offer warranty protection in exchange for a fee.

2. You may modify your copy or copies of the Program or any portion of it, thus forming a work based on the Program, and copy and distribute such modifications or work under the terms of Section 1 above, provided that you also meet all of these conditions:

a) You must cause the modified files to carry prominent notices stating that you changed

the files and the date of any change.

b) You must cause any work that you distribute or publish, that in whole or in part contains or is derived from the Program or any part thereof, to be licensed as a whole at no charge to all third parties under the terms of this License.

c) If the modified program normally reads commands interactively when run, you must cause it, when started running for such interactive use in the most ordinary way, to print or display an announcement including an appropriate copyright notice and a notice that there is no warranty (or else, saying that you provide a warranty) and that users may redistribute the program under these conditions, and telling the user how to view a copy of this License. (Exception: if the Program itself is interactive but does not normally print such an announcement, your work based on the Program is not required to print an announcement.)

These requirements apply to the modified work as a whole. If identifiable sections of that work are not derived from the Program, and can be reasonably considered independent and separate works in themselves, then this License, and its terms, do not apply to those sections when you distribute them as separate works. But when you distribute the same sections as part of a whole which is a work based on the Program, the distribution of the whole must be on the terms of this License, whose permissions for other licensees extend to the entire whole, and thus to each and every part regardless of who wrote it.

Thus, it is not the intent of this section to claim rights or contest your rights to work written entirely by you; rather, the intent is to exercise the right to control the distribution of derivative or collective works based on the Program. In addition, mere aggregation of another work not based on the Program with the Program (or with a work based on the Program) on a volume of a storage or distribution medium does not bring the other work under the scope of this License.

3. You may copy and distribute the Program (or a work based on it, under Section 2) in object code or executable form under the terms of Sections 1 and 2 above provided that you also do one of the following:

a) Accompany it with the complete corresponding machine-readable source code, which must be distributed under the terms of Sections 1 and 2 above on a medium customarily used for software interchange; or,

b) Accompany it with a written offer, valid for at least three years, to give any third party, for a charge no more than your cost of physically performing source distribution, a complete machine-readable copy of the corresponding source code, to be distributed under the terms of Sections 1 and 2 above on a medium customarily used for software interchange; or,

c) Accompany it with the information you received as to the offer to distribute corresponding source code. (This alternative is allowed only for noncommercial distribution and only if you received the program in object code or executable form with such an offer, in accord with Subsection b above.)

The source code for a work means the preferred form of the work for making modifications to it. For an executable work, complete source code means all the source code for all modules it contains, plus any associated interface definition files, plus the scripts used to control compilation and installation of the executable. However, as a special exception, the source code distributed need not include anything that is normally distributed (in either source or binary form) with the major components (compiler, kernel, and so on) of the operating system on which the executable runs, unless that component itself accompanies the executable.

If distribution of executable or object code is made by offering access to copy from a designated place, then offering equivalent access to copy the source code from the same place counts as distribution of the source code, even though third parties are not compelled to copy the source along with the object code.

4. You may not copy, modify, sublicense, or distribute the Program except as expressly provided under this License. Any attempt otherwise to copy, modify, sublicense or distribute the Program is void, and will automatically terminate your rights under this License. However, parties who have received copies, or rights, from you under this License will not have their licenses terminated so long as such parties remain in full compliance.

5. You are not required to accept this License, since you have not signed it. However, nothing else grants you permission to modify or

distribute the Program or its derivative works. These actions are prohibited by law if you do not accept this License. Therefore, by modifying or distributing the Program (or any work based on the Program), you indicate your acceptance of this License to do so, and all its terms and conditions for copying, distributing or modifying the Program or works based on it.

6. Each time you redistribute the Program (or any work based on the Program), the recipient automatically receives a license from the original licensor to copy, distribute or modify the Program subject to these terms and conditions. You may not impose any further restrictions on the recipients' exercise of the rights granted herein. You are not responsible for enforcing compliance by third parties to this License.

7. If, as a consequence of a court judgment or allegation of patent infringement or for any other reason (not limited to patent issues), conditions are imposed on you (whether by court order, agreement or otherwise) that contradict the conditions of this License, they do not excuse you from the conditions of this License. If you cannot distribute so as to satisfy simultaneously your obligations under this License and any other pertinent obligations, then as a consequence you may not distribute the Program at all. For example, if a patent license would not permit royalty-free redistribution of the Program by all those who receive copies directly or indirectly through you, then the only way you could satisfy both it and this License would be to refrain entirely from distribution of the Program.

If any portion of this section is held invalid or unenforceable under any particular circumstance, the balance of the section is intended to apply and the section as a whole is intended to apply in other circumstances.

It is not the purpose of this section to induce you to infringe any patents or other property right claims or to contest validity of any such claims; this section has the sole purpose of protecting the integrity of the free software distribution system, which is implemented by public license practices. Many people have made generous contributions to the wide range of software distributed through that system in reliance on consistent application of that system; it is up to the author/donor to decide if he or she is willing to distribute software through any other system and a licensee cannot impose

that choice.

This section is intended to make thoroughly clear what is believed to be a consequence of the rest of this License.

8. If the distribution and/or use of the Program is restricted in certain countries either by patents or by copyrighted interfaces, the original copyright holder who places the Program under this License may add an explicit geographical distribution limitation excluding those countries, so that distribution is permitted only in or among countries not thus excluded. In such case, this License incorporates the limitation as if written in the body of this License.

9. The Free Software Foundation may publish revised and/or new versions of the General Public License from time to time. Such new versions will be similar in spirit to the present version, but may differ in detail to address new problems or concerns. Each version is given a distinguishing version number. If the Program specifies a version number of this License which applies to it and „any later version“, you have the option of following the terms and conditions either of that version or of any later version published by the Free Software Foundation. If the Program does not specify a version number of this License, you may choose any version ever published by the Free Software Foundation.

10. If you wish to incorporate parts of the Program into other free programs whose distribution conditions are different, write to the author to ask for permission. For software which is copyrighted by the Free Software Foundation, write to the Free Software Foundation; we sometimes make exceptions for this. Our decision will be guided by the two goals of preserving the free status of all derivatives of our free software and of promoting the sharing and reuse of software generally.

## NO WARRANTY

11. BECAUSE THE PROGRAM IS LICENSED FREE OF CHARGE, THERE IS NO WARRANTY FOR THE PROGRAM, TO THE EXTENT PERMITTED BY APPLICABLE LAW. EXCEPT WHEN OTHERWISE STATED IN WRITING THE COPYRIGHT HOLDERS AND/OR OTHER PARTIES PROVIDE THE PROGRAM „AS IS“WITHOUT WARRANTY OF ANY KIND, EITHER EXPRESSED OR IMPLIED, INCLUDING,

BUT NOT LIMITED TO, THE IMPLIED WARRANTIES OF MERCHANTABILITY AND FITNESS FOR A PARTICULAR PURPOSE. THE ENTIRE RISK AS TO THE QUALITY AND PERFORMANCE OF THE PROGRAM IS WITH YOU. SHOULD THE PROGRAM PROVE DEFECTIVE, YOU ASSUME THE COST OF ALL NECESSARY SERVICING, REPAIR OR CORRECTION.

12. IN NO EVENT UNLESS REQUIRED BY APPLICABLE LAW OR AGREED TO IN WRITING WILL ANY COPYRIGHT HOLDER, OR ANY OTHER PARTY WHO MAY MODIFY AND/OR REDISTRIBUTE THE PROGRAM AS PERMITTED ABOVE, BE LIABLE TO YOU FOR DAMAGES, INCLUDING ANY GENERAL, SPECIAL, INCIDENTAL OR CONSEQUENTIAL DAMAGES ARISING OUT OF THE USE OR INABILITY TO USE THE PROGRAM (INCLUDING BUT NOT LIMITED TO LOSS OF DATA OR DATA BEING RENDERED INACCURATE OR LOSSES SUSTAINED BY YOU OR THIRD PARTIES OR A FAILURE OF THE PROGRAM TO OPERATE WITH ANY OTHER PROGRAMS), EVEN IF SUCH HOLDER OR OTHER PARTY HAS BEEN ADVISED OF THE POSSIBILITY OF SUCH DAMAGES.

END OF TERMS AND CONDITIONS

### How to Apply These Terms to Your New Programs

If you develop a new program, and you want it to be of the greatest possible use to the public, the best way to achieve this is to make it free software which everyone can redistribute and change under these terms.

To do so, attach the following notices to the program. It is safest to attach them to the start of each source file to most effectively convey the exclusion of warranty; and each file should have at least the "copyright" line and a pointer to where the full notice is found.

<one line to give the program's name and a brief idea of what it does>Copyright (C) <year> <name of author>

This program is free software; you can redistribute it and/or modify it under the terms of the GNU General Public License as published by the Free Software Foundation; either version 2 of the License, or (at your option) any later version.

This program is distributed in the hope that it will be useful, but WITHOUT ANY WARRANTY; without even the implied warranty of MERCHANTABILITY or FITNESS FOR A PARTICULAR PURPOSE. See the GNU General Public License for more details.

You should have received a copy of the GNU General Public License along with this program; if not, write to the Free Software Foundation, Inc., 59 Temple Place, Suite 330, Boston, MA 02111-1307 USA

IV.

If requested by you, the complete corresponding source code of the Software can be sent by Snom Technology GmbH on a standard data storage medium against the reimbursement of the manufacturing costs of EUR 5.- per unit.

The complete corresponding source code of the Software can also be downloaded from our web site <https://www.snom.com/footer/source-code-gpl-open-source/>.

V.

For further information see <http://www.snom.com>.

VTECH COMMUNICATIONS, INC.

Tigard, Oregon 97223, USA.

Copyright © 2019 Snom Technology GmbH. All Rights Reserved.

v2019005 Version 5, 11/19